

**ALUMINCO**  
ALUMINIUM BUILDING SYSTEMS

**DOOR  
PANELS**





## Περιεχόμενα | Index

Προφίλ εταιρείας Company profile	2-3
Ευρετήριο σχεδίων Design index	4-7
<b>P100 Series</b>	8-27
<b>Inox Series</b>	28-51
<b>E2000 Series</b>	52-107
<b>P6000 Series</b>	108-125
<b>AL590 Security door lock</b>	126 127
Ταμπλαδάκια Special size panels	128
<b>FP20</b> Aluplast / PVC	129
Χειρολαβές Handles	130-131

Η ALUMINCO, με έδρα τα Οινόφυτα Βοιωτίας, είναι η πρώτη εταιρία στον κλάδο που από την ίδρυσή της ξεκίνησε με την παραγωγή προϊόντων από καυτό αλουμίνιο πάνω σε παραδοσιακά μοτίβα. Σήμερα, αξιοποιώντας 31 χρόνια εμπειρίας στον χώρο, έχει μετεξελιχθεί σε μια ολοκληρωμένη, κάθετη βιομηχανία αλουμινίου. Στο κέντρο παραγωγής της διατηρεί ολοκληρωμένες μονάδες επεξεργασίας, ηλεκτροστατικής βαφής, μοντάζ, φινιρίσματος, συσκευασίας και αποθήκευσης των προϊόντων που παράγει και παραδίδει.

Η ALUMINCO προσφέρει σύγχρονες αρχιτεκτονικές και κατασκευαστικές λύσεις με βάση το αλουμίνιο, στις οποίες περιλαμβάνονται:

- Πλήρης σειρά ανοιγόμενων και συρόμενων συστημάτων αλουμινίου, ψυχρών και θερμομονωτικών.
- Πληθώρα σχεδίων σε πάνελ αλουμινίου για κάθε αρχιτεκτονική και κατασκευαστική ανάγκη με έμφαση στην αισθητική, τη λειτουργικότητα και την ασφάλεια.
- Πόρτες ασφαλείας και θωρακισμένες πόρτες για κύριες εισόδους επαγγελματικών ή ιδιωτικών κτιρίων. Διατίθενται σε παραδοσιακό ή σύγχρονο στυλ, σε μεγάλη ποικιλία σχεδίων και χρωμάτων.
- Συστήματα καγκέλων για μπαλκόνια, βεράντες και σκάλες. Σε παραδοσιακά και μοντέρνα σχέδια, από καυτό αλουμίνιο, προφίλ αλουμινίου ή τύπου inox συνδυασμένα με πολυκαρμπονικά φύλλα.
- Συστήματα εξωτερικών χώρων όπως πέργκολες, αίθρια, στέγαστρα εισόδων, αυλόπορτες, αυλόγυροι και φωτιστικά, προσφέροντας ολοκληρωμένες λύσεις στην κατασκευή κτιρίων υψηλών απαιτήσεων.

Με εξαγωγική δραστηριότητα σε πάνω από 60 χώρες σε όλο τον κόσμο, η ALUMINCO είναι προσηλωμένη στον τομέα της συνεχούς έρευνας και ανάπτυξης προϊόντων που ανταποκρίνονται ποιοτικά, αισθητικά και λειτουργικά στις απαιτητικές και ταχύτατα εξελισσόμενες αγορές.

Η διαδικασία βαφής των προϊόντων της βασίζεται στις προδιαγραφές QUALICOAT και SEASIDE CLASS (επεξεργασία παραθαλάσσιας κλάσης) ενώ τηρεί σύστημα διαχείρισης ποιότητας κατά ISO 9001 και σύστημα περιβαλλοντικής διαχείρισης κατά ISO 14001.

Όλα τα συστήματα αλουμινίου και καγκέλων σχεδιάζονται, αναπτύσσονται και δοκιμάζονται στο τμήμα Έρευνας & Ανάπτυξης της εταιρείας και στη συνέχεια πιστοποιούνται από αναγνωρισμένα ινστιτούτα και διεθνείς οργανισμούς όπως το IFT Rosenheim Γερμανίας, το Istituto Giordano Ιταλίας, το EKANAΛ (Ελληνικό Κέντρο Ανάπτυξης Αλουμινίου) Ελλάδας κ.α.

Η ALUMINCO οδηγεί τις εξελίξεις στον τομέα του αλουμινίου, αναβαθμίζοντας συνεχώς τις υπηρεσίες και τα προϊόντα που προσφέρει, με ολοκληρωμένες λύσεις που καλύπτουν τις ανάγκες της σύγχρονης κατασκευής και βελτιώνουν την ποιότητα ζωής δημιουργώντας σχέσεις εμπιστοσύνης με τον τεχνικό κόσμο και το καταναλωτικό κοινό.

ALUMINCO, situated in Inofita (40km from Athens & 70km of the int. airport EL. BENIZELOS), Viotia, is the first company of this sector that, since its establishment, began the production of items made of cast aluminium on traditional patterns. Today, with 31 years of experience, our company has evolved to an integrated vertical aluminium industry. The production center includes integrated processing units, units of powder coating, assembling, finishing, packaging and storage.

ALUMINCO offers aluminium-based modern architectural and constructive solutions, which include:

- A complete series of tilt & turn sliding and thermal break aluminium systems.
- Several series of on aluminium panels for any architectural and building need, emphasizing on aesthetics, functionality and safety.
- Safety doors and reinforced doors for main entrances of any building. Available in traditional or modern styles, in a large variety of designs and colors.
- Railing systems for balconies, verandahs and stairs. In traditional and modern designs, of cast aluminium or inox type combined with polycarbonate panels.
- Outdoor systems, such as pergolas, patios, entrance canopies, yards and lighting, offering integrated solutions for buildings of high demands.

Our exporting experience to more than 60 countries throughout the world, keeps ALUMINCO dedicated to product research and development, satisfying the qualitative, aesthetic and functional needs of the demanding and rapidly developing markets.

The powder coating procedure is based on QUALICOAT specifications for SEASIDE CLASS; our company conforms to the quality system ISO 9001 and the system of environmental management ISO 14001.

All aluminium and railing systems are designed, developed and tested by the department of Research & Development and then are certified by recognized institutes and international organizations, such as IFT Rosenheim of Germany, Istituto Giordano of Italy, EKANAΛ (Greek Center of Aluminium Development of Greece), etc.



# ΚΑΤΑΛΟΓΟΣ ΠΕΡΙΕΧΟΜΕΝΩΝ ΜΕ ΔΙΑΣΤΑΣΕΙΣ ΣΧΕΔΙΩΝ

# CATALOGUE INDEX WITH DESIGN DIMENSIONS

P100 Series

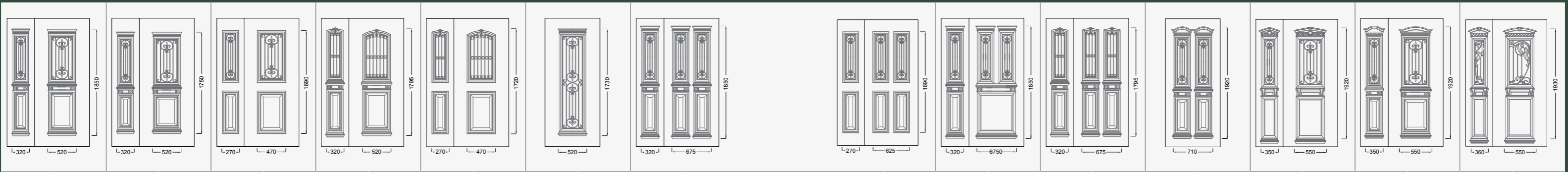

P105-P100 Pg.12-13 P105K-P100K Pg.27 P106-P101 Pg.10-11 P115-P110 Pg.16-17 P116-P111 Pg.16 P124 Pg.13 P105-P130 Pg.14 P106-P131 Pg.21 P105-P136 Pg.15 P115-P140 Pg.16 P164 Pg.19 P138-P168 Pg.25-26 P177-P176 Pg.18, 20 P129-P189 Pg.23-24

I300 Series

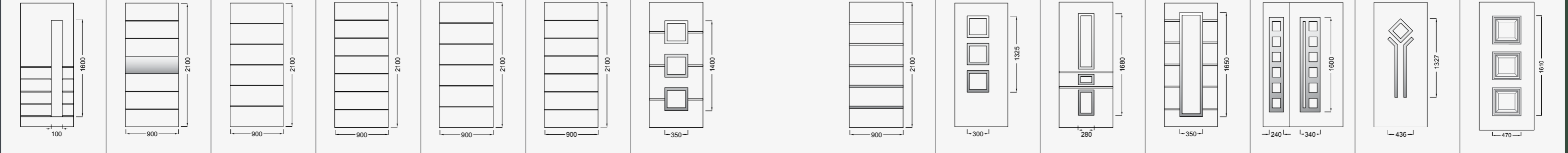

I221 Pg.33 I224 Pg.35 I225 Pg.31 I226 Pg.30 I235 Pg.34 I236 Pg.34 I240 Pg.32 I245 Pg.30 I253 Pg.33 I260 Pg.32 I270 Pg.33 I313-I300 Pg.45 I310 Pg.44 P190 Pg.22

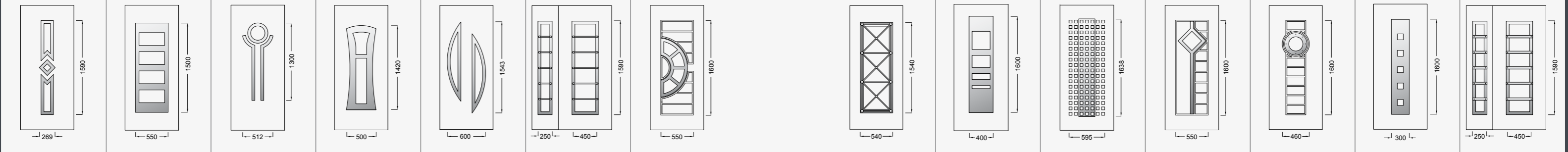

I320 Pg.44 I325 Pg.46 I330 Pg.44 I335 Pg.49 I340 Pg.46 I383-I343 Pg.36 I345 Pg.47 I347 Pg.36 I350 Pg.49 I357 Pg.42 I362 Pg.50 I372 Pg.50 I375 Pg.50 I388-I378 Pg.37

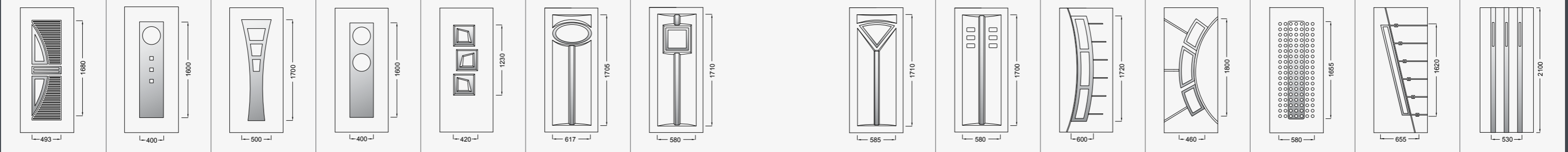

I380 Pg.48 I385 Pg.48 I392 Pg.51 I396 Pg.43 I400 Pg.38 I405 Pg.38 I410 Pg.39 I415 Pg.38 I417 Pg.39 I420 Pg.45 I425 Pg.45 I429 Pg.39 I450 Pg.40 I455 Pg.41

E2000 Series

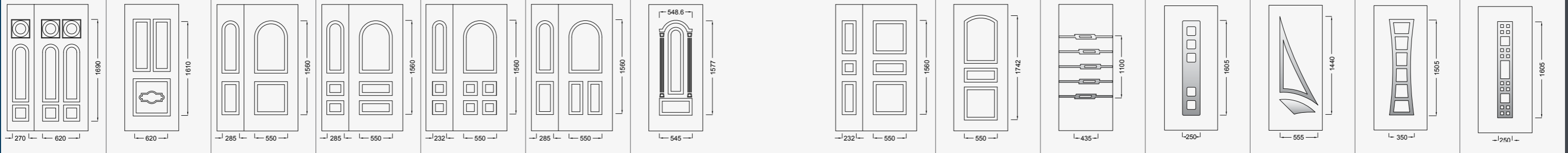

E210-E200 Pg.106 E507 Pg.54 E903-E510 Pg.62-63 E504-E512 Pg.62-64 E588-E513 Pg.62, 64 E903-E517 Pg.62, 65 E528 Pg.56 E810-E530 Pg.60 E532 Pg.57 I460 Pg.40 I465 Pg.41 I480 Pg.43 I490 Pg.43 I495 Pg.42

# ΚΑΤΑΛΟΓΟΣ ΠΕΡΙΕΧΟΜΕΝΩΝ ΜΕ ΔΙΑΣΤΑΣΕΙΣ ΣΧΕΔΙΩΝ

# CATALOGUE INDEX WITH DESIGN DIMENSIONS

E2000 Series

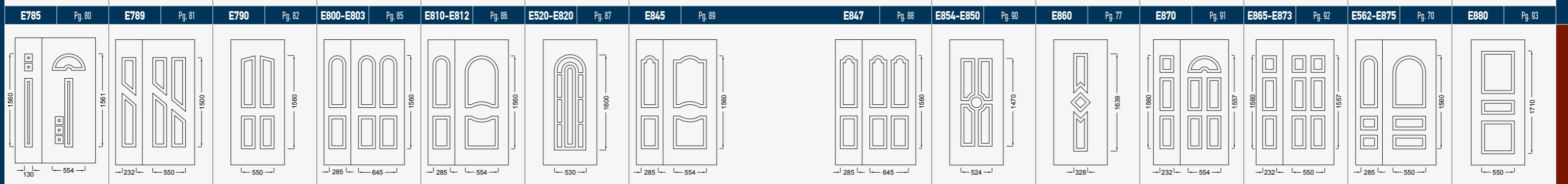
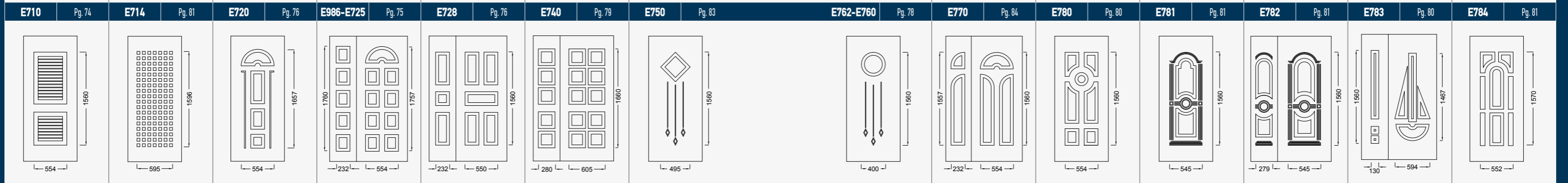
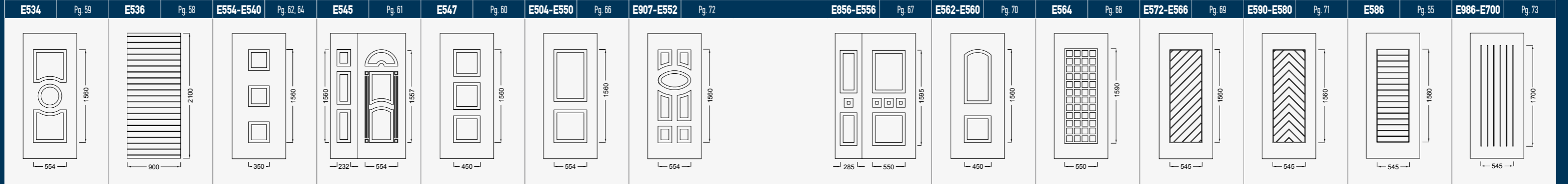
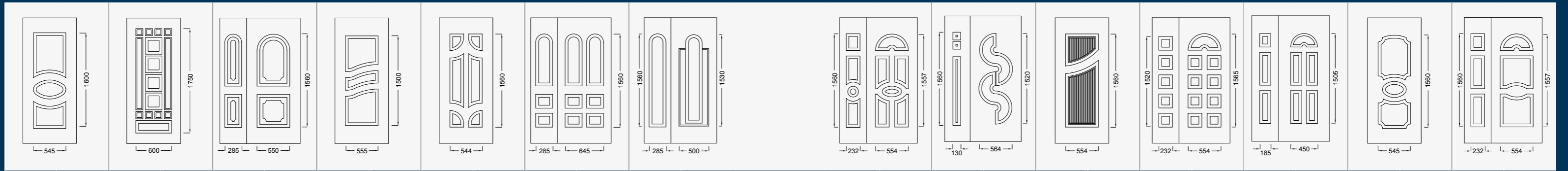

P6000 Series

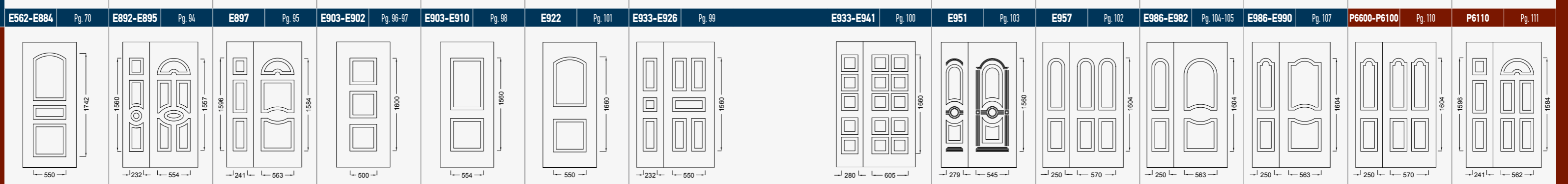

P6120 Pg. 112 P6630-P6130 Pg. 114 P6750-P6140 Pg. 115 P6150 Pg. 116 P6160 Pg. 119 P6170 Pg. 120 P6680-P6180 Pg. 125 P6690-6190 Pg. 113 P6700-P6200 Pg. 117 P6710-P6210 Pg. 122 P6710-P6220 Pg. 121 P6740-P6230 Pg. 118, 125 P6740-P6240 Pg. 123 P6750-P6250 Pg. 124

# P100 Series

# Παραδοσιακό | Traditional



P102

P102K



P103

P112



P113

P152



- Νεοκλασικός χαρακτήρας
- Φύλλο αλουμινίου 1.2 mm
- Τζάμια με ασφάλειες αλουμινίου
- Επιλογή ανοιγόμενου παραθύρου
- Εύκολη και άμεση αντικατάσταση τζαμιών με βίδες
- Μεγάλη γκάμα σχεδίων και κατασκευών
- Αναλλοίωτες και πιστοποιημένες βαφές και αποχρώσεις ξύλου
- Δεν χρειάζεται συντήρηση

- Traditional and classic design
- 1.2 mm Aluminium sheet
- Window with aluminium decorative safety
- Opening window option
- Quick and easy glass replacement with screws
- Multiple design option
- Certified powder coatings and wood imitation shades
- Maintenance free

ΠΑΧΟΣ ΦΥΛΛΟΥ ΑΛΟΥΜΙΝΙΟΥ ALUMINIUM SHEET THICKNESS	1.2 mm
ΠΑΧΟΣ ΔΙΑΚΟΣΜΗΤΙΚΟΥ ΧΥΤΟΥ DECORATIVE CAST THICKNESS	4 mm
ΣΥΝΟΛΙΚΟ ΠΑΧΟΣ ΠΑΝΕΛ TOTAL PANEL THICKNESS	23-25 mm
ΑΠΟΚΟΛΛΗΣΗ ΚΟΡΝΙΖΑΣ ΑΠΟ ΕΠΙΦΑΝΕΙΑ ΤΟΥ ΠΑΝΕΛ FRAME DETACHMENT FROM PANEL SURFACE	50,02 Pa/mm <sup>2</sup>
ΑΠΟΚΟΛΛΗΣΗ ΦΥΛΛΟΥ ΑΛΟΥΜΙΝΙΟΥ ΑΠΟ ΜΟΝΩΤΙΚΟ SHEET DETACHMENT FROM INSULATION MATERIAL	0,488 N/mm <sup>2</sup>
ΣΥΝΤΕΛΕΣΤΗΣ ΘΕΡΜΙΚΗΣ ΑΝΤΙΣΤΑΣΗΣ THERMAL RESISTANCE COEFFICIENT	RD = m <sup>2</sup> * K/W = 0,55
ΣΥΝΤΕΛΕΣΤΗΣ ΘΕΡΜΙΚΗΣ ΑΓΩΓΙΜΟΤΗΤΑΣ THERMAL CONDUCTIVITY COEFFICIENT	λd = W/M * K = 0,035



P142



P143



P162



P132



P133



P190

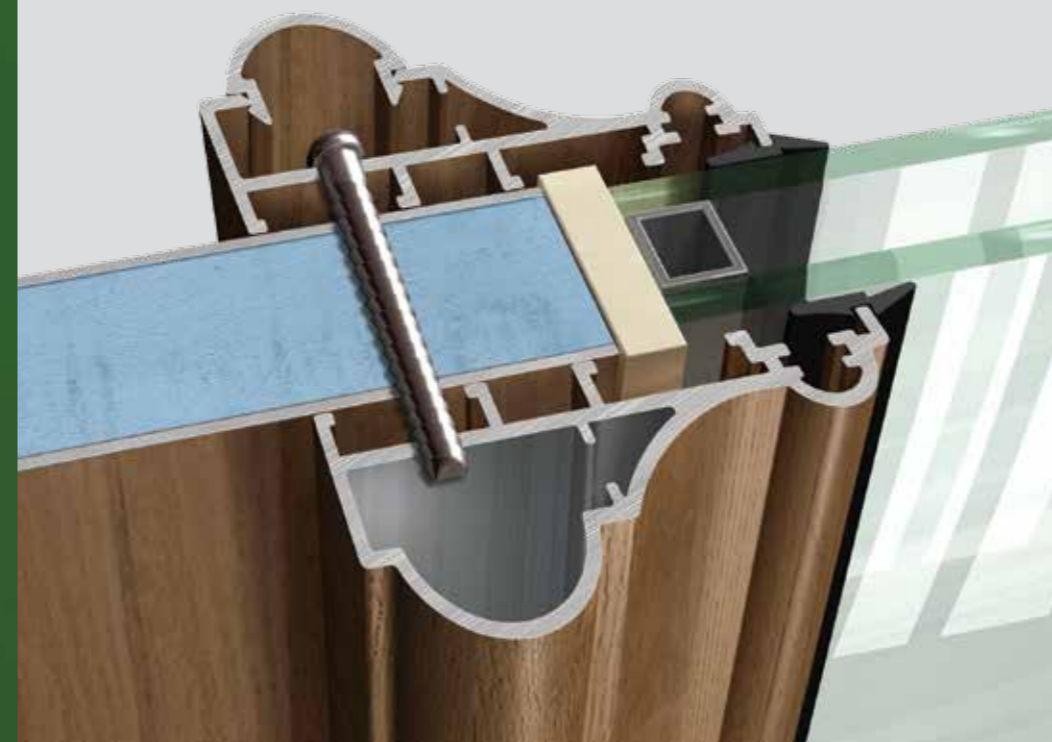

# P100 Series

Classic



Επιλογή διακοσμητικής ασφάλειας  
εσωτερικά του κρυστάλλου.  
Decorative safety option



P121



P181

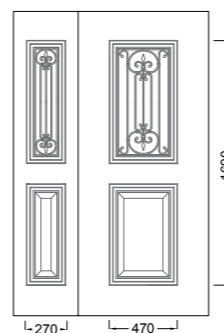

P106

P101



Επιλογή Vitro  
Vitro option

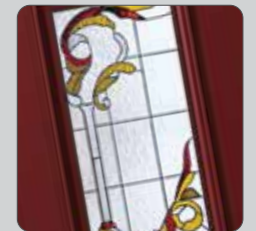

Vitro-A K (Brown)

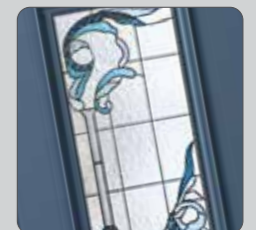

Vitro-A M (Blue)



Vitro-A Π (Green)



Vitro-B Λ (White)



Vitro-B M (Blue)

P159 Vitro-B K (Brown)

P158 Vitro-B K (Brown)

# P100 Series

Classic



P105

P100

Επιλογή διακοσμητικής ασφάλειας  
εσωτερικά του κρυστάλλου.  
Decorative safety option



P125

P120



P175

P170



P183



P155 Vitro-A K (Brown)

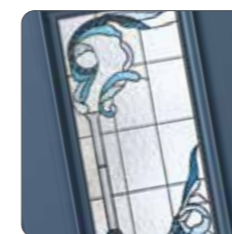

Vitro-A M (Blue)

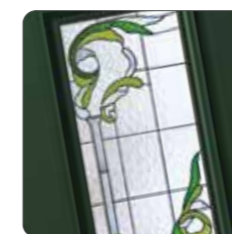

Vitro-A Π (Green)



P124

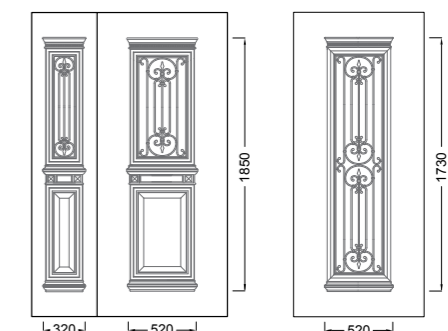

# P100 Series

Classic



P175

P171

Επιλογή διακοσμητικής ασφάλειας  
εσωτερικά του κρυστάλλου.  
Decorative safety option



P130



P150

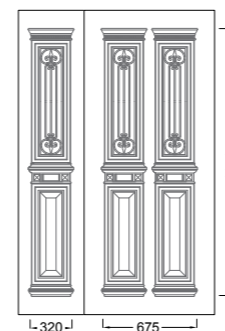

P105

P136

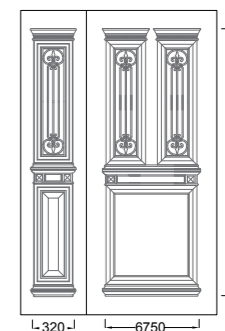



# P100 Series

Classic



P140



P116

P111



P115

P110



P115 Vitro-B M (Blue)

P110 Vitro-B M (Blue)

Επιλογή Vitro  
Vitro option



Vitro-B Λ (White)

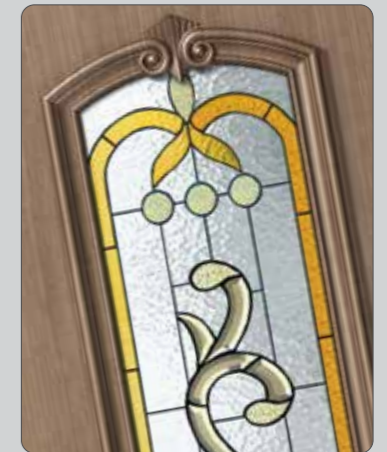

Vitro-B Κ (Brown)

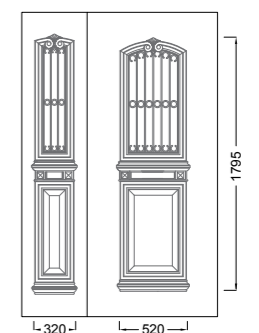
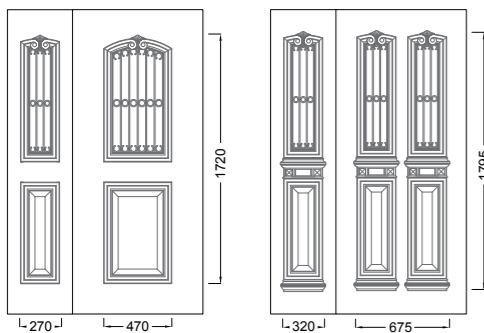

# P100 Series

Classic



P185

P180

Επιλογή διακοσμητικής ασφάλειας  
εσωτερικά του κρυστάλλου.  
Decorative safety option



P177

P176



P179

P178



P160



P162



P182



P164



P163

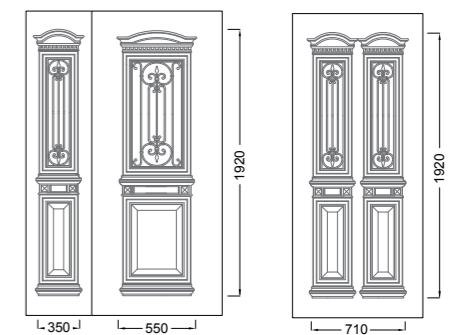

# P100 Series

Classic



P153 Vitro-A M (Blue)

P154 Vitro-A M (Blue)



P152



P154 Vitro-A П (Green)



P151



P161

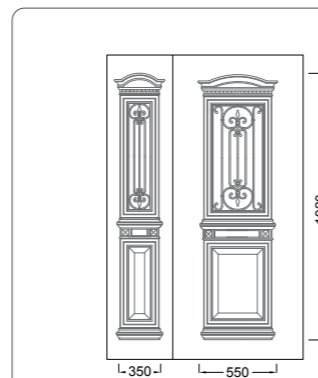

P151



P156 Vitro-A K (Brown)

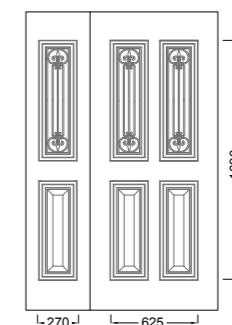

# P100 Series

Classic



P193



P191



P129

P189

Επιλογή διακοσμητικής ασφάλειας  
εσωτερικά του κρυστάλλου.  
Decorative safety option



P109

P149



P128

P148

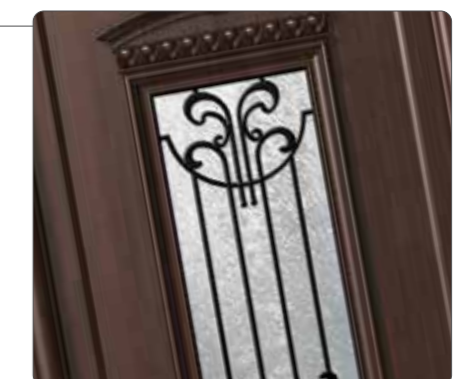
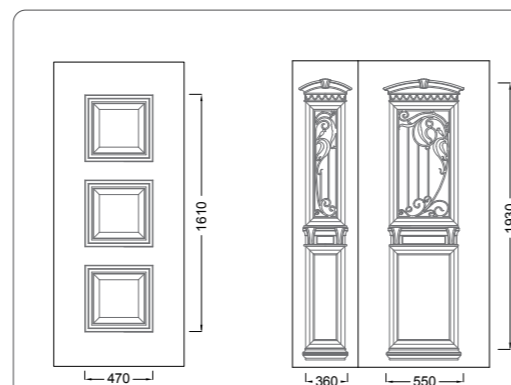

P198

# P100 Series

Classic



P129 Vitro-A Π (Green)

P189 Vitro-A Π (Green)



Vitro-A M (Blue)

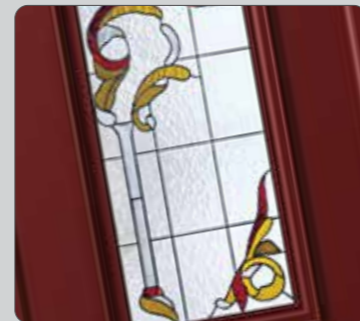

Vitro-A K (Brown)

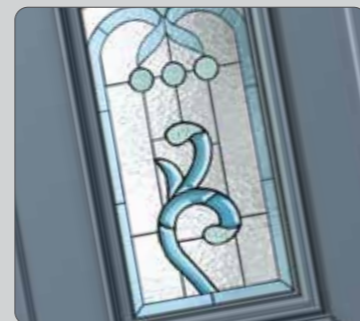

Vitro-B M (Blue)

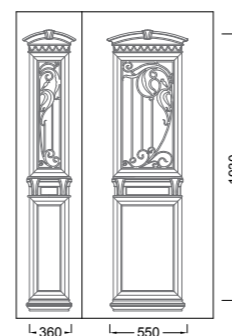

P138 Vitro-B K (Brown)

P168 Vitro-B K (Brown)

Επιλογή Vitro  
Vitro option



Vitro-B Λ (White)

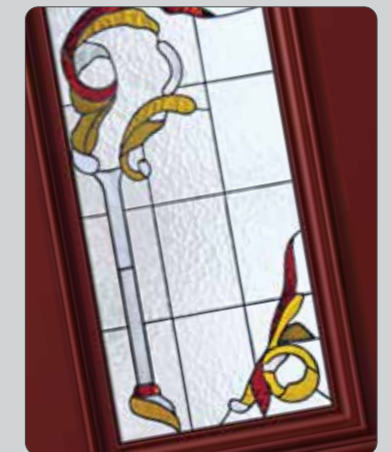

Vitro-A K (Brown)

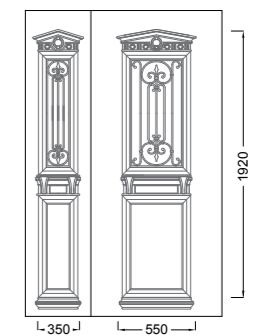

# P100 Series

Classic



P138

P168

Επιλογή διακοσμητικής ασφάλειας  
εσωτερικά του κρυστάλλου.  
Decorative safety option



P194

P174



P114

P169

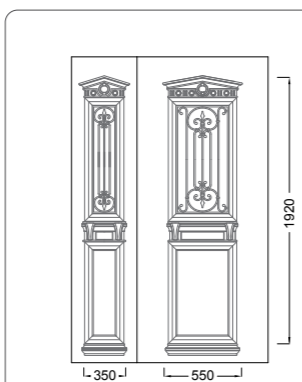

P199

## ΕΙΔΙΚΟ ΣΧΕΔΙΟ

Για πόρτες με ύψος κάτω από 2m.

## SPECIAL DESIGN

Ideal for doors less than 2m height.

# K



P107 K

P102 K



P175 K

P170 K



P105 K

P100 K

# I300 Series

## Μοντέρνο | Modern



1460



1455



1466



- Έντονα μοντέρνος χαρακτήρας
- Τζάμια διπλής υάλωσης
- Επιλογές ειδικά καταργασμένων τζαμιών Fused υψηλής αισθητικής και αυξημένης αντοχής
- Αυξημένη θερμομόνωση & ηχομόνωση
- Αναλλοίωτες και πιστοποιημένες βαφές και αποχρώσεις ξύλου

- Innovative design
- Double glazing
- Fused glazing with Inox for extra resistance and high aesthetics
- Exceptional heat and sound insulation coefficient
- Certified powder coatings and wood imitation shades

ΠΑΧΟΣ ΦΥΛΛΟΥ ΑΛΟΥΜΙΝΙΟΥ  
ALUMINIUM SHEET THICKNESS

1,2 mm      2mm

ΣΥΝΟΛΙΚΟ ΠΑΧΟΣ ΠΑΝΕΛ  
TOTAL PANEL THICKNESS

23-25 mm      24-26 mm

ΑΠΟΚΟΛΛΗΣΗ ΚΟΡΝΙΖΑΣ ΑΠΟ  
ΕΠΙΦΑΝΕΙΑ ΤΟΥ ΠΑΝΕΛ  
FRAME DETACHMENT FROM PANEL  
SURFACE

50,02 Pa/mm<sup>2</sup>

ΑΠΟΚΟΛΛΗΣΗ ΦΥΛΛΟΥ ΑΛΟΥΜΙΝΙΟΥ  
ΑΠΟ ΜΟΝΩΤΙΚΟ  
SHEET DETACHMENT FROM  
INSULATION MATERIAL

0,488 N/mm<sup>2</sup>

ΣΥΝΤΕΛΕΣΤΗΣ ΘΕΡΜΙΚΗΣ ΑΝΤΙΣΤΑΣΗΣ  
THERMAL RESISTANCE COEFFICIENT

RD = m<sup>2</sup> \* K/W = 0,55

ΣΥΝΤΕΛΕΣΤΗΣ ΘΕΡΜΙΚΗΣ  
ΑΓΩΓΙΜΟΤΗΤΑΣ  
THERMAL CONDUCTIVITY COEFFICIENT

λd = W/M \* K = 0,035



# I300 Series

Πάχος φύλλου αλουμινίου 2mm  
Aluminium sheet thickness 2mm



# Flat Line

Door Panels Catalogue **ALUMINCO**  
ALUMINIUM BUILDING SYSTEMS



I226



I245



I225

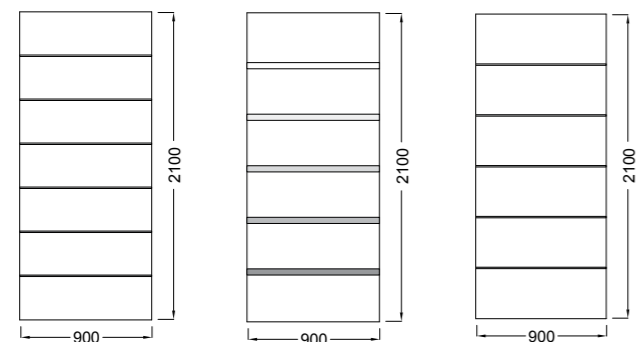

- Πάχος φύλλου αλουμινίου 2mm
- Χάραξη πάνελ 1mm σε μορφή «Π»
- Λωρίδες Inox 10mm & 20mm
- Σχέδια πάνελ με 5 & 6 διακοσμητικές λωρίδες Inox

- Aluminium sheet thickness 2mm
- 1mm milling in «Π» shape
- 10mm & 20mm Inox lines
- Panel design with 5 & 6 Inox lines



# I300 Series

Πάχος φύλλου αλουμινίου 2mm  
Aluminium sheet thickness 2mm

# Flat Line



I243 Deco 4



I263 Deco 3



I221 Super Silver



I253 Deco 3

I253 Deco 6



I271 Super Silver

Διακοσμητικό καθρεπτιζόν τζάμι Super Silver. Καθρέπτης εξωτερικά, φθοριωμένο τζάμι εσωτερικά.

Decorative mirror glass Super Silver. Mirror effect outside, fluoridated glass inside.

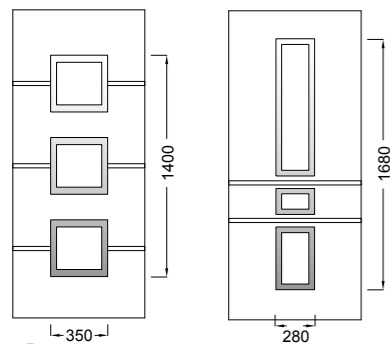

I263 Deco 4

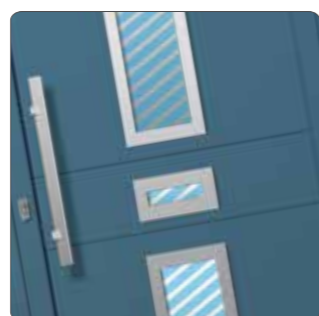

I263 Deco 1



I263 Deco 8

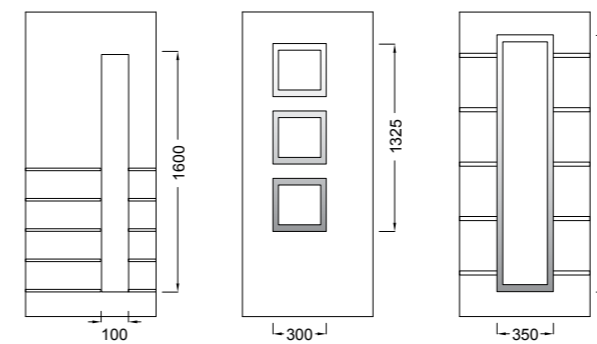

# I300 Series

Πάχος φύλλου αλουμινίου 2mm  
Aluminium sheet thickness 2mm



# Flat Line

Door Panels Catalogue **ALUMINCO**  
ALUMINIUM BUILDING SYSTEMS



I236 (6 Διακοσμητικές γραμμές / 6 Decorative lines)



I235 (5 Διακοσμητικές γραμμές / 5 Decorative lines)



I224



- Πάχος φύλλου αλουμινίου 2mm
- Χάραξη πάνελ 0.8mm σε μορφή «V»
- Σχέδια πάνελ με 5 & 6 διακοσμητικές γραμμές

- Aluminium sheet thickness 2mm
- 0.8mm milling in «V» shape
- Panel design with 5 & 6 milled lines

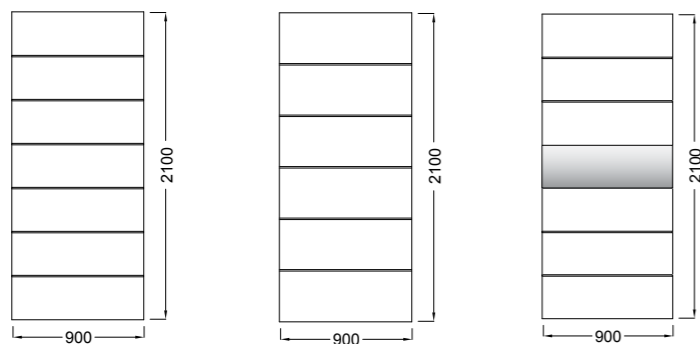

# I300 Series

Πάχος φύλλου αλουμινίου 2mm  
Aluminium sheet thickness 2mm



I348 Αμμοβολή/Sand Blasted Glass



I384 Super Silver

I344 Super Silver



I389 Αμμοβολή/Sand Blasted Glass

I379 Αμμοβολή/Sand Blasted Glass



Κουρμπριστή ασφάλεια πάχους 3mm & πλάτους 50mm.

Curved safety with 3mm thickness & 50mm width.

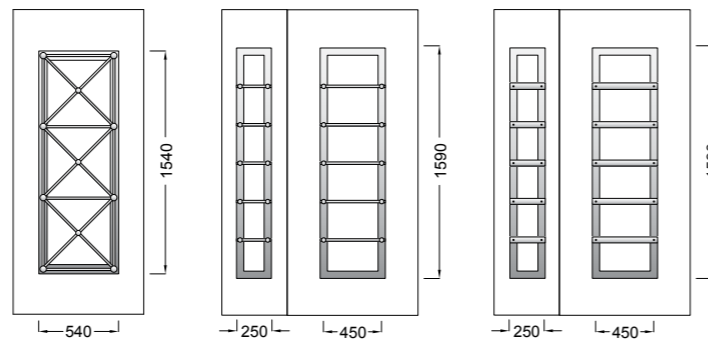

# I300 Series Inox

Πάχος φύλλου αλουμινίου 1,2mm  
Aluminium sheet thickness 1,2mm



# 3D



I406 FU-1



I416 FU-1



I403 FU-1



I417



I411 FU-1



I429

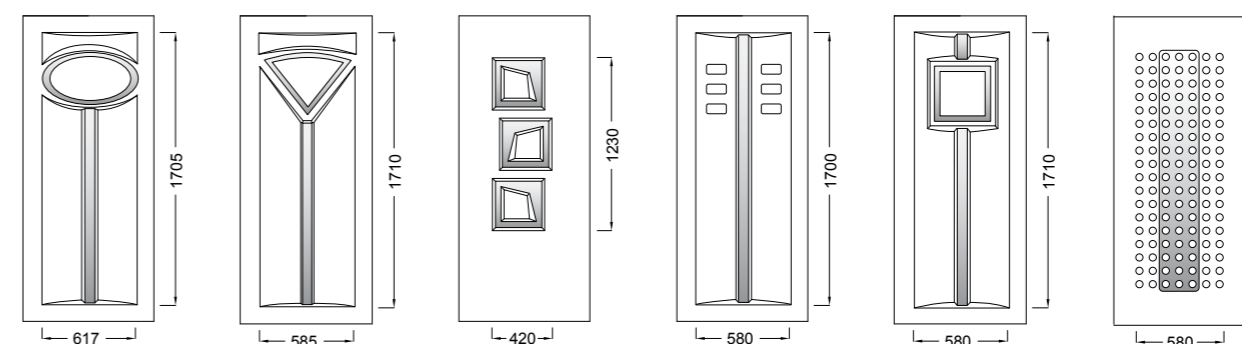

# I300 Series Inox

Πάχος φύλλου αλουμινίου 1,2mm  
Aluminium sheet thickness 1,2mm



I460



I451 Super Silver



I466



I455

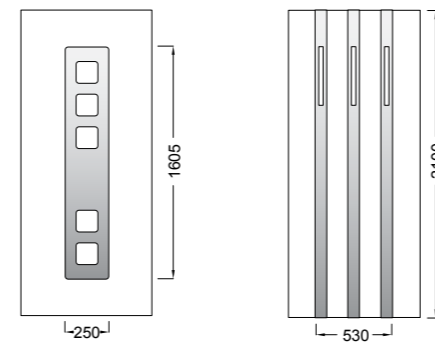
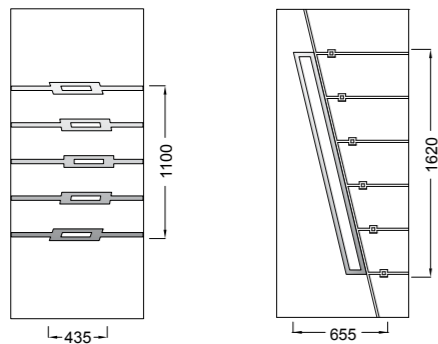

# I300 Series Inox

Πάχος φύλλου αλουμινίου 1,2mm  
Aluminium sheet thickness 1,2mm

1 mm

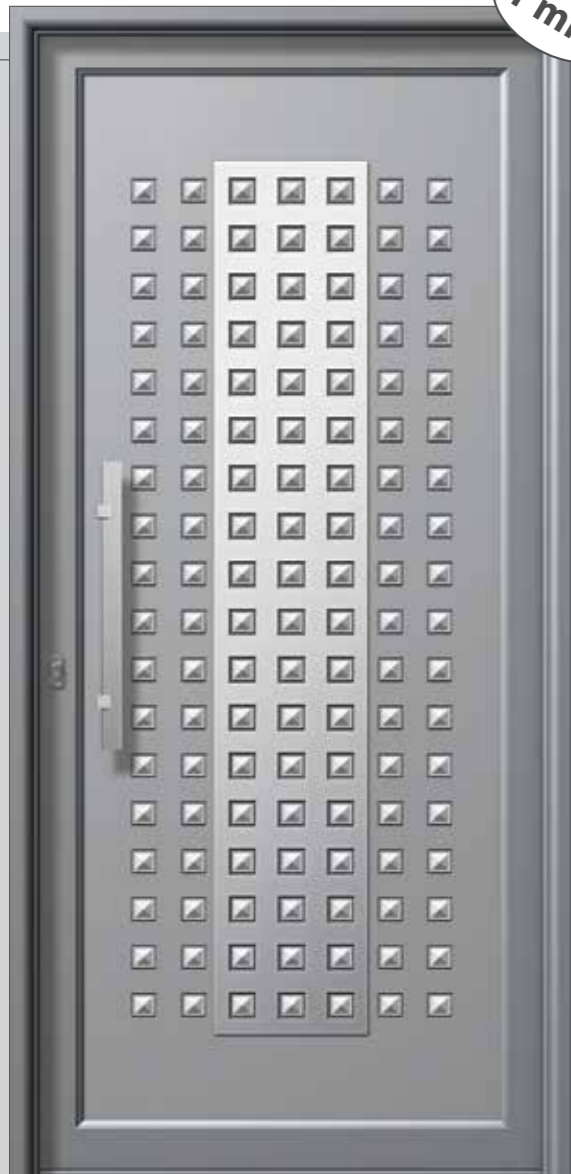

I357



I496 Αμμοβολή/Sand Blasted Glass



I491 BR-2



I481



I398 FU-1

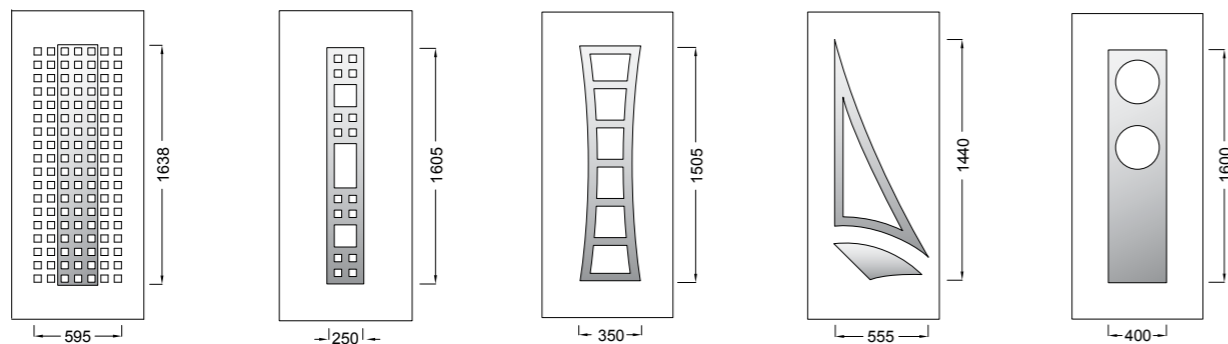

# I300 Series Inox

Πάχος φύλλου αλουμινίου 1,2mm  
Aluminium sheet thickness 1,2mm



I311M CA



I323 FU-1



I315 FU-1

I303 FU-1



I428 Αμμοβολή/Sand Blasted Glass



I331 FU-1



I423 Super Silver

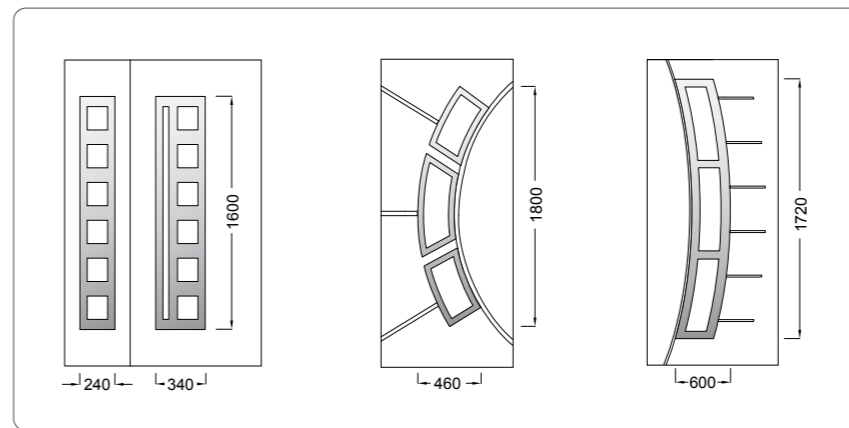
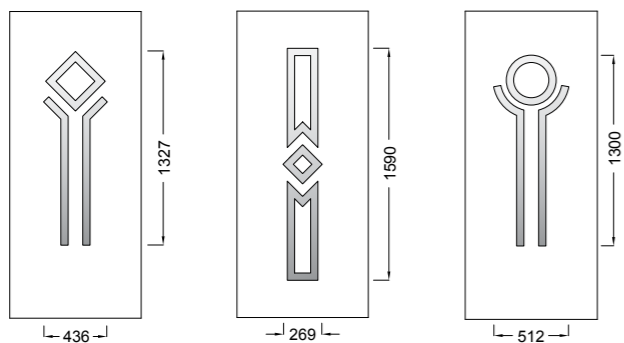

# I300 Series Inox

Πάχος φύλλου αλουμινίου 1,2mm  
Aluminium sheet thickness 1,2mm



I342 FU-2



I327 VI-1

Διακοσμητικά τζάμια  
Decorative glass



I346 BR-2



I346 BR-1



I346 FU-3

Διακοσμητικά τζάμια & Vítro  
Decorative glass & Vítro



I342 FU-1



I327 CA

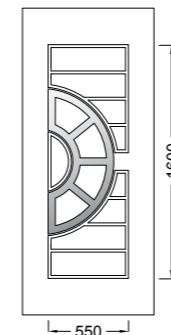
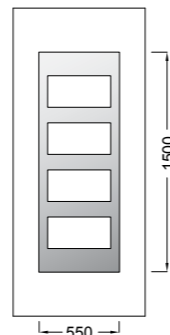



# I300 Series Inox

Πάχος φύλλου αλουμινίου 1,2mm  
Aluminium sheet thickness 1,2mm



I382M FU-1



I387 Super Silver



I354 FU-1



I337M FU-1

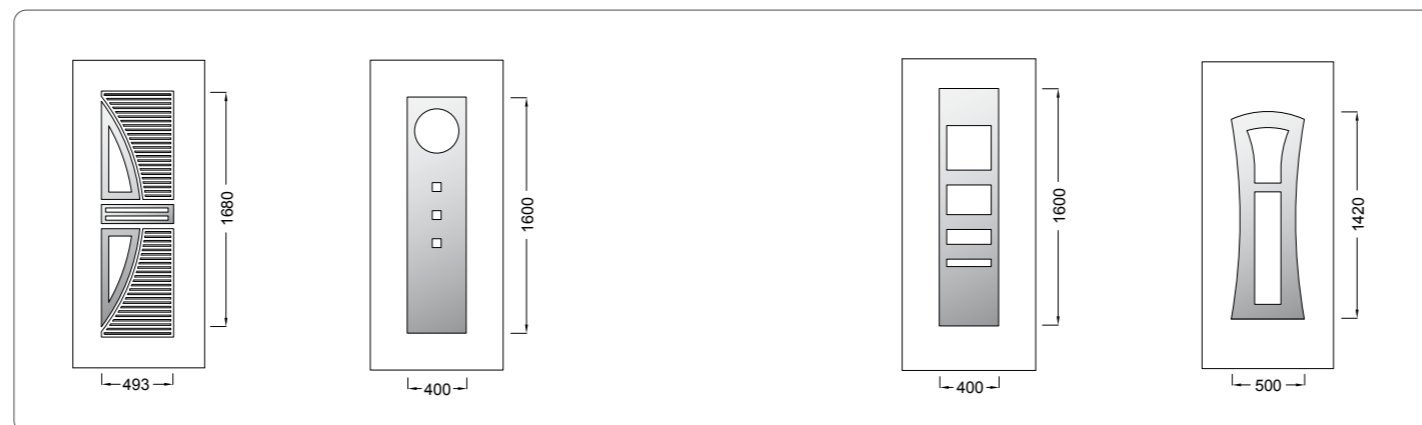

# I300 Series Inox

Πάχος φύλλου αλουμινίου 1,2mm  
Aluminium sheet thickness 1,2mm



I363 Super Silver



I373M FU-1



I376 FU-1

Διακοσμητικά τζάμια  
Decorative glass



I395M FU-1



I395M FU-2



I395M FU-3

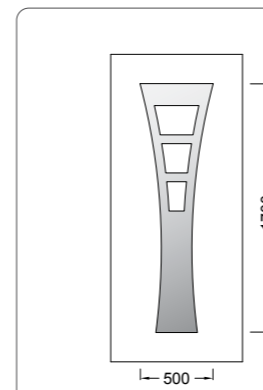
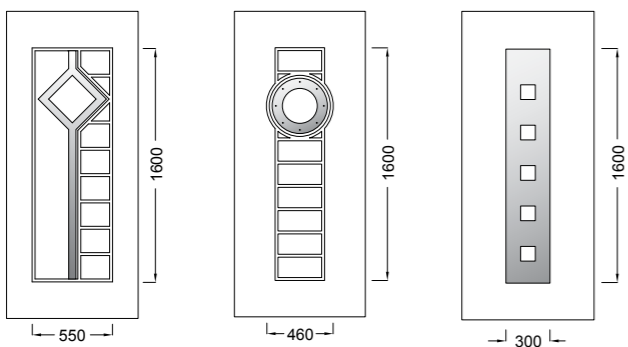

# E2000 Series

## Ευέλικτο | Flexible



E532



E982



- Μοντέρνος χαρακτήρας
- Ευέλικτο design
- Μεγάλη γκάμα κρυστάλλων
- Τζάμια διπλής υάλωσης
- Επιλογές ειδικά κατεργασμένων τζαμιών
- Fused υψηλής αισθητικής και αυξημένης αντοχής\*
- Επιλογές ενσωματωμένων ασφαλειών για αντικλεπτική προστασία
- Τεράστια ποικιλία σχεδίων και κατασκευών
- Αναλλοίωτες και πιστοποιημένες βαφές και αποχρώσεις ξύλου
- Δεν χρειάζεται συντήρηση

- Modern design
- Wide selection of glasses
- Double glazing
- Fused glazing with Inox for extra resistance and high aesthetics\*
- Cast aluminium security for extra protection
- Multiple design option
- Certified powder coatings and wood imitation shades
- Maintenance free

ΠΑΧΟΣ ΦΥΛΛΟΥ ΑΛΟΥΜΙΝΙΟΥ ALUMINIUM SHEET THICKNESS
<b>1 mm</b>
ΣΥΝΟΛΙΚΟ ΠΑΧΟΣ ΠΑΝΕΛ TOTAL PANEL THICKNESS
<b>23-24 mm</b>
ΑΠΟΚΟΛΛΗΣΗ ΚΟΡΝΙΖΑΣ ΑΠΟ ΕΠΙΦΑΝΕΙΑ ΤΟΥ ΠΑΝΕΛ FRAME DETACHMENT FROM PANEL SURFACE
<b>50,02 Pa/mm<sup>2</sup></b>
ΑΠΟΚΟΛΛΗΣΗ ΦΥΛΛΟΥ ΑΛΟΥΜΙΝΙΟΥ ΑΠΟ ΜΟΝΩΤΙΚΟ SHEET DETACHMENT FROM INSULATION MATERIAL
<b>0,488 N/mm<sup>2</sup></b>
ΣΥΝΤΕΛΕΣΤΗΣ ΘΕΡΜΙΚΗΣ ΑΝΤΙΣΤΑΣΗΣ THERMAL RESISTANCE COEFFICIENT
<b>RD = m<sup>2</sup> * K/W = 0,55</b>
ΣΥΝΤΕΛΕΣΤΗΣ ΘΕΡΜΙΚΗΣ ΑΓΩΓΙΜΟΤΗΤΑΣ THERMAL CONDUCTIVITY COEFFICIENT
<b>λd = W/M * K = 0,035</b>

\*Το κάθε τζάμι FUSED είναι διαφορετικό λόγω του ότι είναι χειροποίητο με ειδική κατεργασία ενώ παράλληλα το πραγματικό προϊόν μπορεί να διαφέρει μερικώς από την απεικόνιση του σχεδίου στον κατάλογο.

\*Each FUSED glass is different due to its handmade special procedure so the original product can be partially varied from the catalogue's photo appearance.

# E2000 Series



E507



E508 Καίτη/Transom



E586



E587 Καίτη/Transom Inox



E508 Ασφάλεια 1/Safety 1

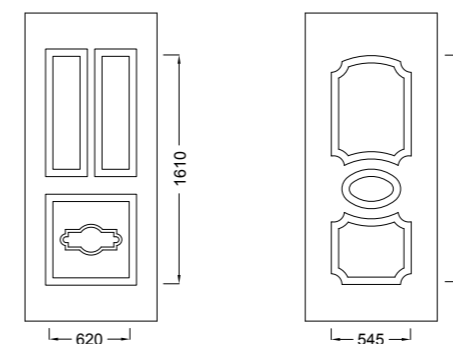

# E2000 Series



E529 Deco 1



E528



E532



E533 Καίτι/Transom

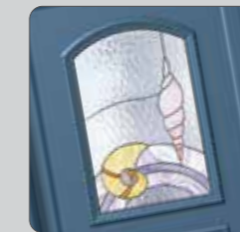

E533 Vitro 2



E533 Ασφάλεια 4/Safety 4

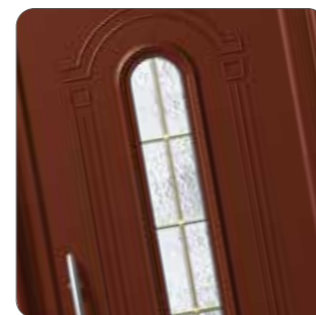

E529 Καίτι/Transom

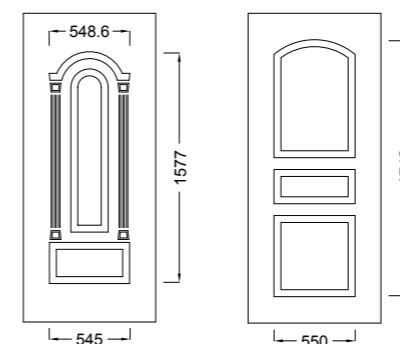

# E2000 Series



E537 Fused 1



E535 Ασφάλεια 1/Safety 1



E534

E537 Ασφάλεια 1/Safety 1



E537 Fused 3



E536

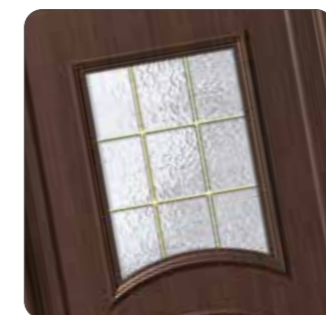
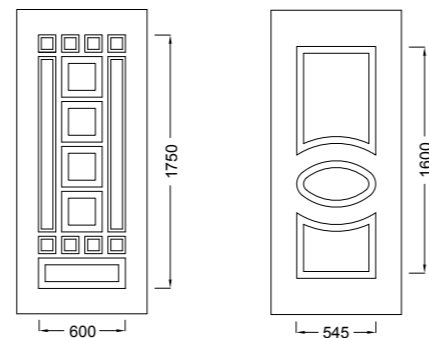

E535 Καίτι/Transom



E535 Fused 1

# E2000 Series



E810

E530



E531 Καίτη/Transom Inox



E531 Ασφάλεια 1/Safety 1



E545

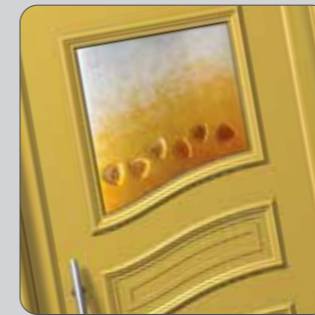

E546 Fused 1



E546 Καίτη/Transom



E546 Fused 2



E548 Καίτη/Transom



E547



E548

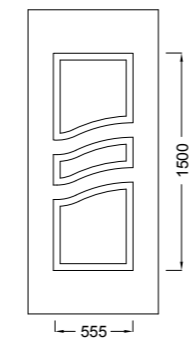
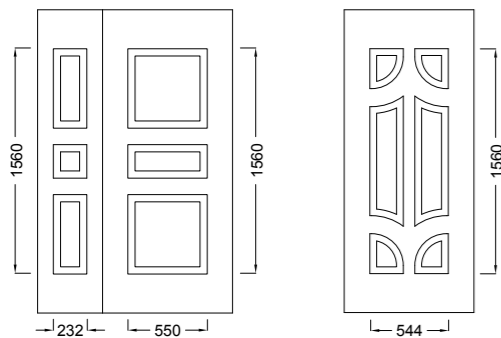

# E2000 Series

Κλασικό Design σε 5 παραλλαγές  
5 Classic Designs



E903                      E510   E504                      E512   E588                      E513



E554                      E540                      E903                      E517



E905 Ασφάλεια 2/Safety 2                      E514 Ασφάλεια 3/Safety 3                      E506 Ασφάλεια 1/Safety 1                      E515 Ασφάλεια 1/Safety 1

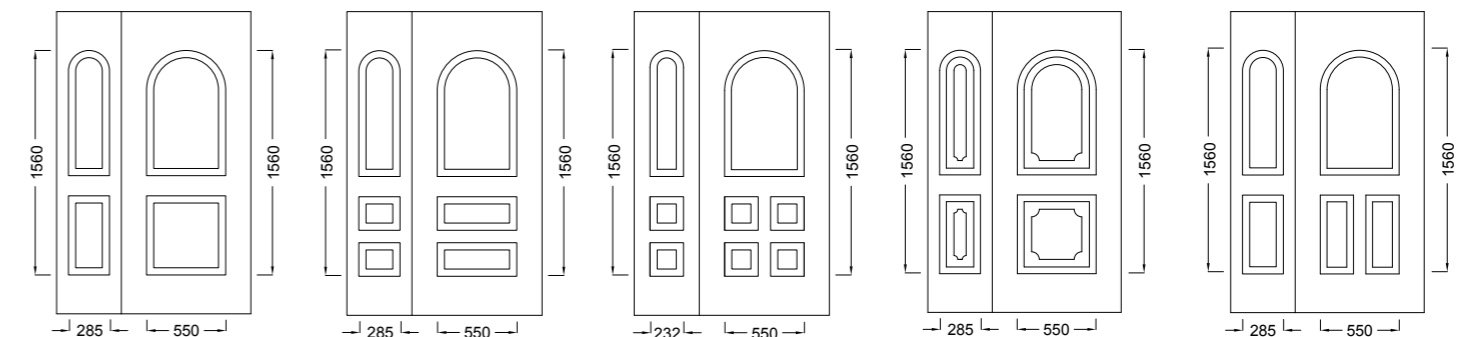



# E2000 Series

Κλασικό Design σε 5 παραλλαγές  
5 Classic Designs



E515 Ασφάλεια 3/Safety 3



E541 Ασφάλεια 1/Safety 1



E516 Ασφάλεια 2/Safety 2



Καίτη/Transom



Vitro 2



E905 Καίτη Ρόμβος/Transom Rhombus

E518 Καίτη Ρόμβος/Transom Rhombus

# E2000 Series



E506 Καράβολο/Karavolo

E551 Καράβολο/Karavolo



E504

E550

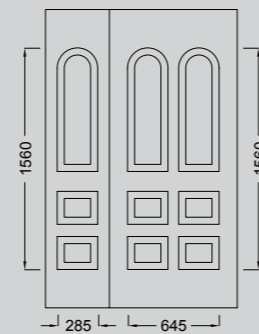

E856

E556

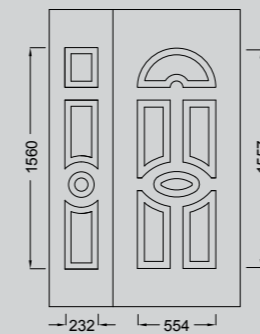

E858

E558 Καίτη/Transom



Αμμοβολή σχέδιο  
Sandblasting with design



Καίτη/Transom



Deco 1



Vitro 1



E557 Καίτη/Transom Inox

# E2000 Series



E565 Ασφάλεια 1/Safety 1



E564



E575 Fused 7

E569 Fused 7



E572

E566



Fused 1

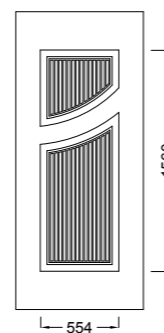

Fused 6



Ασφάλεια 5/Safety 5

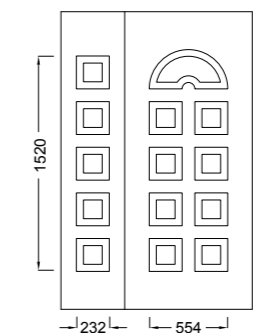

# E2000 Series



E562



E875



E563



E878



E562



E884

**ΕΙΔΙΚΟ ΣΧΕΔΙΟ 45cm ΠΛΑΤΟΣ  
SPECIAL DESIGN 45cm WIDTH**



E590



E580



E592 Καίτη/Transom



E583 Καίτη/Transom



E563



E886



E563



E561

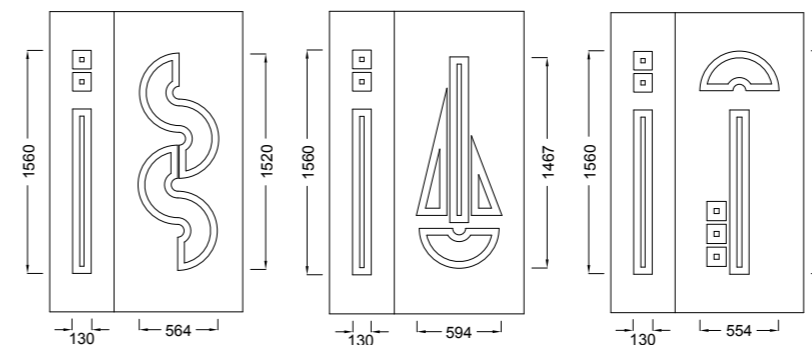

Ειδικό σχέδιο / Special design

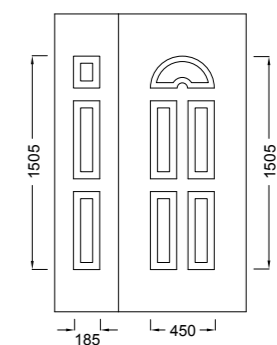

# E2000 Series



E908 Deco 2



E552

E553 Deco 2



E988 Fused 4

E702 Fused 4



E700



E702 Ασφάλεια 5/Safety 5



Deco 1



Ασφάλεια 1/Safety 1

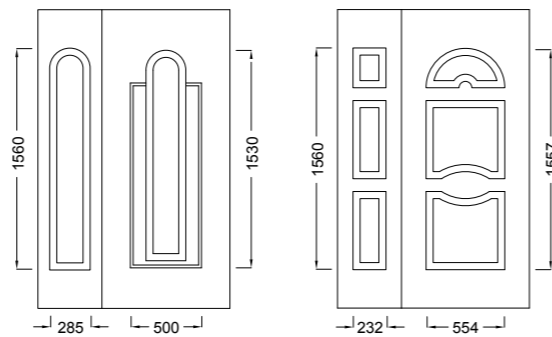

E701 Fused 4



E702 Καΐτι/Transom



E711 Ασφάλεια 2/Safety 2



E727 Fused 9



E727 Ασφάλεια 6/Safety 6

E711 Καίτι/Transom Inox



E710



Καίτι/Transom



Fused 4

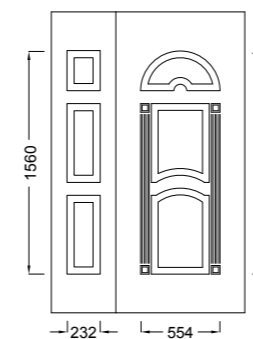
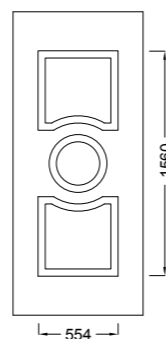

E725



Καίτι/Transom

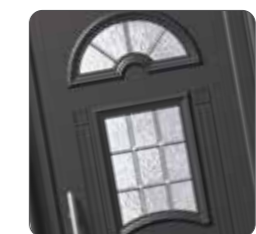

Καίτι/Transom Inox

# E2000 Series



E731 Ασφάλεια 1/Safety 1



E729 Ασφάλεια 1/Safety 1



E720



E728

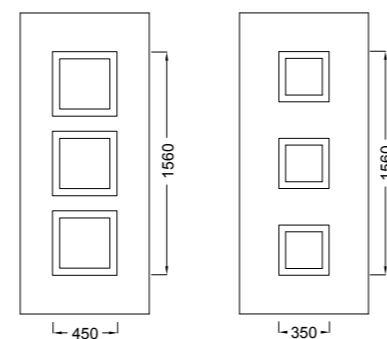

E860

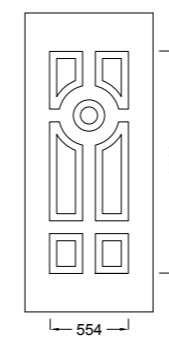

E864



E864 Καίτη/Transom Inox



E864 Ασφάλεια 1/Safety 1

# E2000 Series



E761 Καίτι/Transom



E740



E741 Ασφάλεια 4/Safety 4



E741 Ασφάλεια 1/Safety 1

E761 Ασφάλεια 5/Safety 5



E760

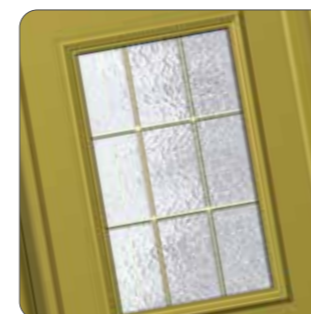
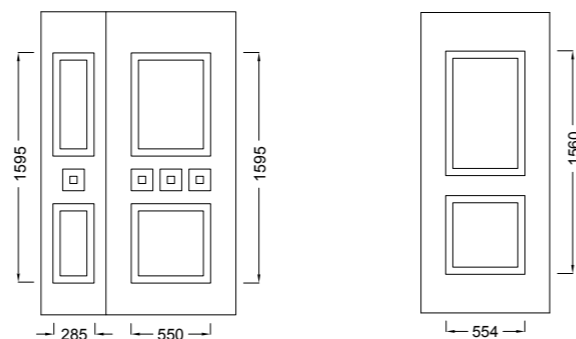

Καίτι/Transom

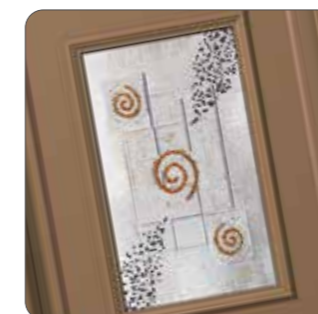

Fused 2



Ασφάλεια 3/Safety 3



# E2000 Series



E783



E780



E785



E781



E789



E784



E782



E714

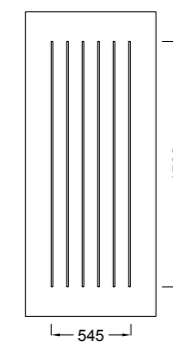
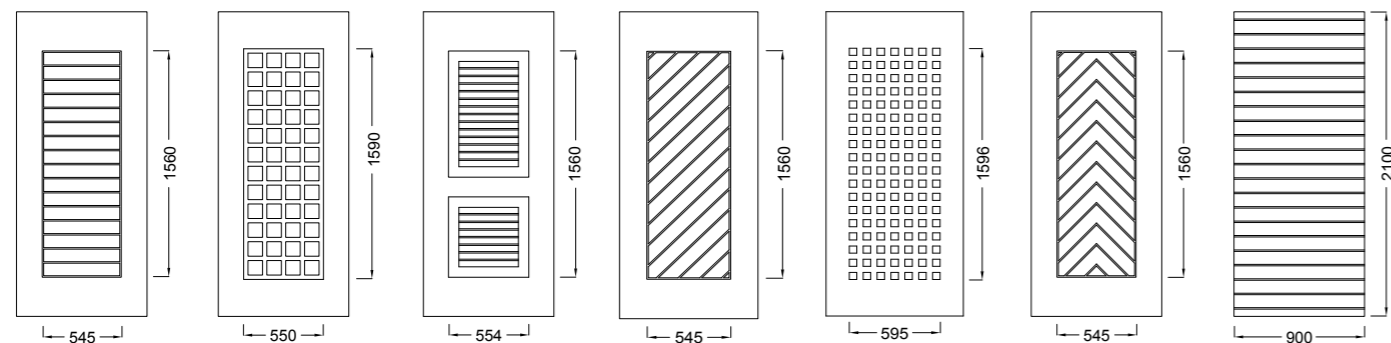

# E2000 Series



E792 Ασφάλεια 4/Safety 4



Καίτη/Transom Inox



E790



E791 Καίτη/Transom



E750

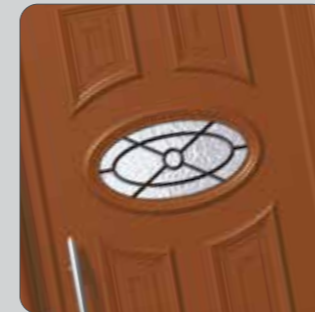

Ασφάλεια 1/Safety 1



E751 Deco 1

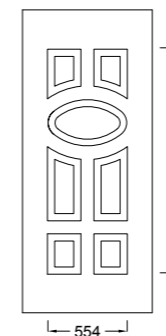
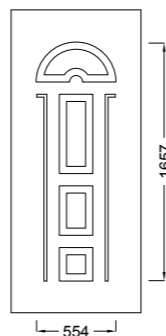



E771 Καίτι/Transom Inox



E770



E771 Ασφάλεια 3  
Safety 3



E771 Ασφάλεια 1/Safety 1



E800



E803 E801 Fused 4

E807 Fused 4

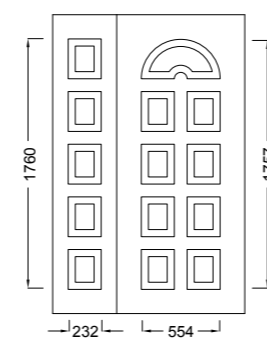
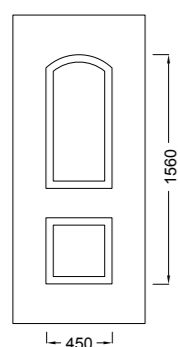

Καίτι/Transom



Ασφάλεια 4/Safety 4



E812



E811 Καίτι/Transom Inox

E814 Καίτι/Transom Inox



E520



E820 E523 Ασφάλεια 1/Safety 1

E826 Ασφάλεια 1/Safety 1

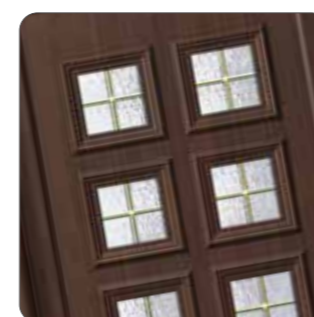
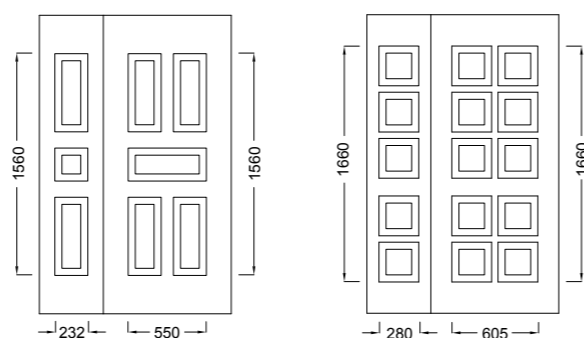

Καίτι/Transom



Fused 3

# E2000 Series



E848 Ασφάλεια 1/Safety 1



E848 Καίτη/Transom Inox



E846 Ασφάλεια 1/Safety 1



E846 Fused 1



E847



Fused 1

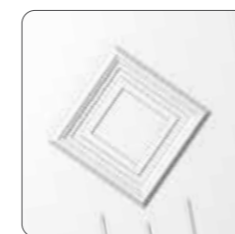
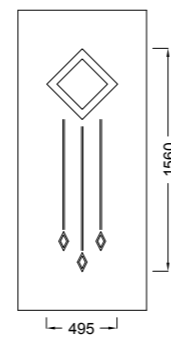
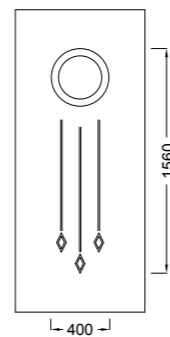

E845



Καίτη/Transom

# E2000 Series



E851 Ασφάλεια 4/Safety 4

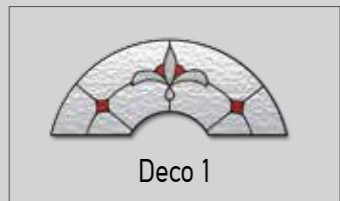

Deco 1



E855L Καίτη/Transom

E851 Καίτη/Transom

E855R Καίτη/Transom



E870



E871 Deco 1



E871 Ασφάλεια 3/Safety 3



E850

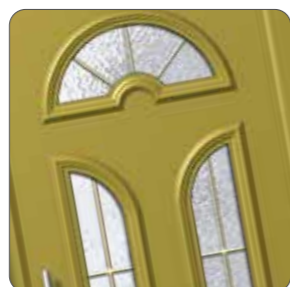

E853 Καίτη/Transom

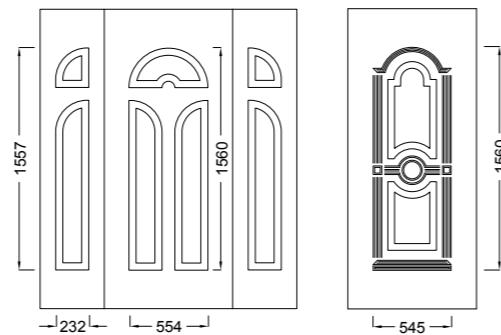

Καίτη/Transom



Ασφάλεια 1/Safety 1



Ασφάλεια 2/Safety 2

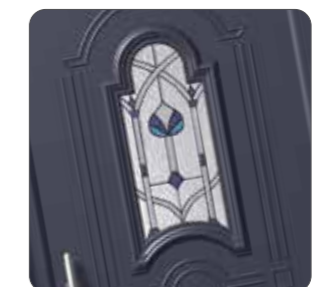

Deco 2

# E2000 Series



E865



E873 E866

E874 Καίτη/Transom



E881 Deco 2



E880



Καίτη/Transom



E881 Ασφάλεια 1/Safety 1



Vitro 1



Deco 1



Ασφάλεια 2/Safety 2



Ασφάλεια 3/Safety 3

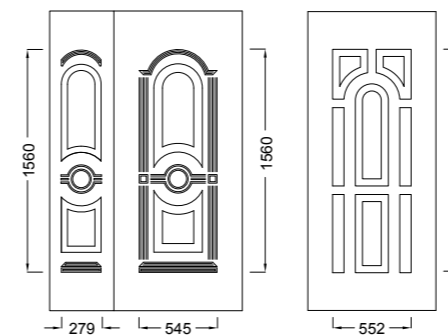

# E2000 Series



E899 Fused 1



E893 Καίτι/Transom Inox

E896 Καίτι/Transom Inox



E897



E898 Καίτι/Transom



E895

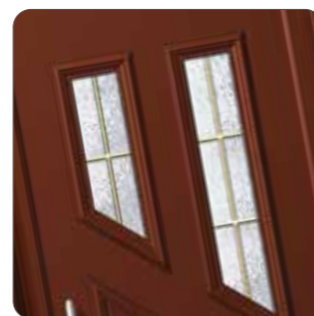

Καίτι/Transom

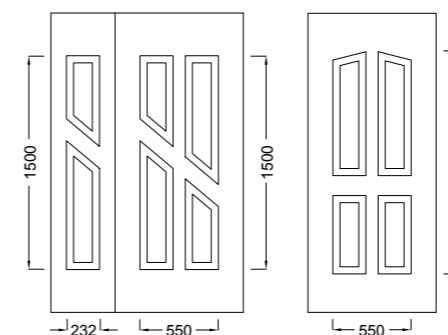



# E2000 Series



E905 Vitro 3



E900 Vitro 3

E905 Καράβολο/Karavolo

E900 Καράβολο/Karavolo



E900 Deco 2

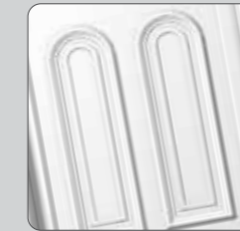

E902



Καίτη/Transom



Αμμοβολή σχέδιο  
Sandblasting with design



E900 Deco 1



Asφάλεια 1/Safety 1



Asφάλεια 2/Safety 2

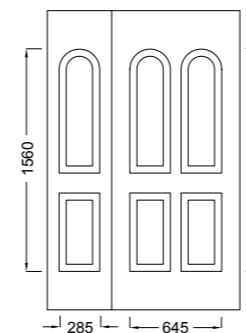

# E2000 Series



E905 Ασφάλεια 1/Safety 1

E911 Ασφάλεια 1/Safety 1



E911 Ασφάλεια 2/Safety 2



E934 Ασφάλεια 1/Safety 1

E928 Ασφάλεια 1/Safety 1



E928 Ασφάλεια 2/Safety 2



E910

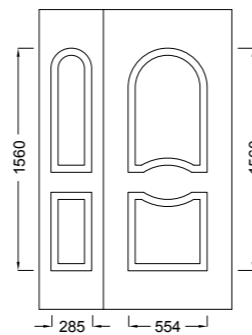

E926

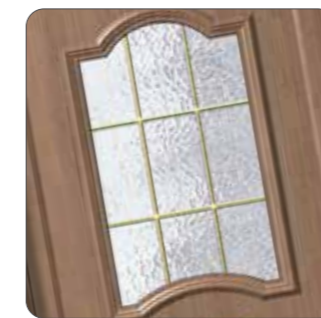

Καίτη/Transom

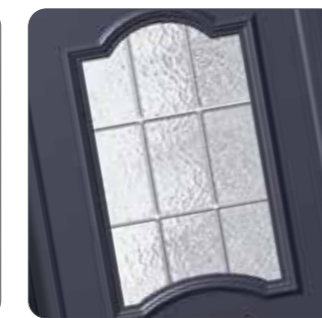

Καίτη/Transom Inox

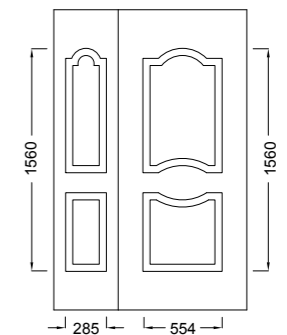

# E2000 Series



E943 Ασφάλεια 1/Safety 1



E941



Καίτη/Transom



E943 Ασφάλεια 3/Safety 3



E922

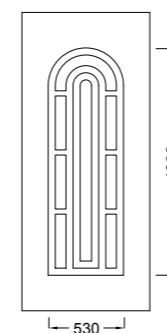
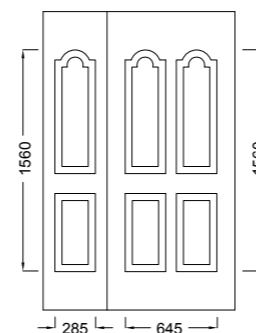

E924



E960 Vitro 1



E958



E952 Καίτη/Transom Inox



E951



Καίτη/Transom



E954 Fused 2



E957

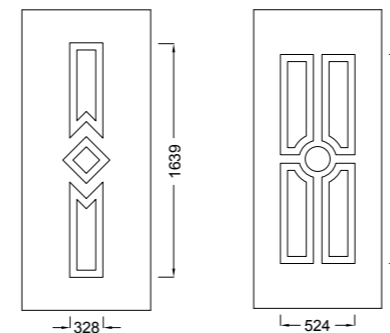

# E2000 Series



E988 Vitro 1



E983 Vitro 1

E988 Fused 1

E983 Fused 1



E983 Ασφάλεια 1/Safety 1



E982



E983 Καίτι/Transom



E981 Καίτι Inox  
Transom Inox



E983 Καράβολο/Karavolo



Fused 2



Fused 3



Vitro 2

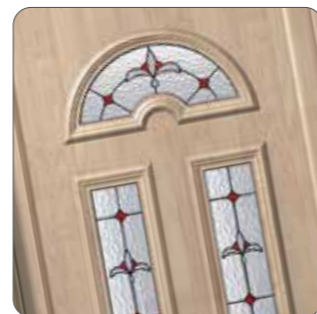

Deco 1

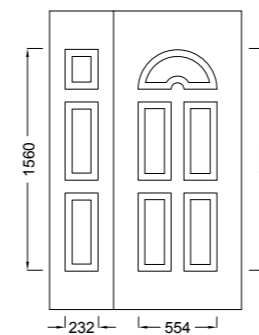

# E2000 Series



E210



E200 E212 Ασφάλεια 1/Safety 1

E204 Ασφάλεια 1/Safety 1



E986



E990 E988 Καίτη/Transom

E994 Καίτη/Transom



Vitro 1

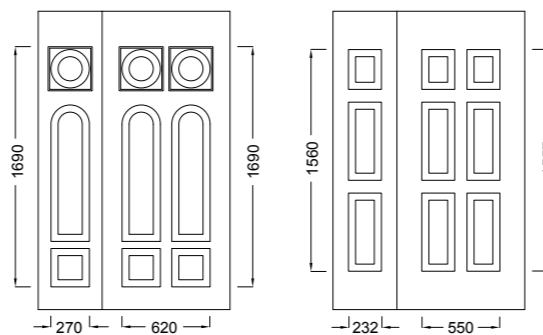

# P6000 Series

## Ασφάλεια | Security



P6110



P6150



- Ασφάλεια
- Στιβαρή κατασκευή βαρέως τύπου με ενισχυμένα φύλλα αλουμινίου 1,5mm
- Εξωτερικό πάτημα με ενσωματωμένο ταμπλά αλουμινίου
- Τζάμια διπλής υάλωσης με triplex τζάμι ασφαλείας
- Αυξημένη θερμομόνωση & ηχομόνωση
- Αναλλοίωτες και πιστοποιημένες βαφές και αποχρώσεις ξύλου

- Safety and protection
- Heavy duty pressed aluminium panel 1.5mm thickness
- Double glazing with triplex safety glass
- Exceptional heat and sound insulation coefficient
- Certified powder coatings and wood imitation shades

ΠΑΧΟΣ ΦΥΛΛΟΥ ΑΛΟΥΜΙΝΙΟΥ  
ALUMINIUM SHEET THICKNESS

1,2 mm

ΣΥΝΟΛΙΚΟ ΠΑΧΟΣ ΠΑΝΕΛ  
TOTAL PANEL THICKNESS

23-25 mm

ΑΠΟΚΟΛΛΗΣΗ ΚΟΡΝΙΖΑΣ ΑΠΟ  
ΕΠΙΦΑΝΕΙΑ ΤΟΥ ΠΑΝΕΛ  
FRAME DETACHMENT FROM PANEL  
SURFACE

50,02 Pa/mm<sup>2</sup>

ΑΠΟΚΟΛΛΗΣΗ ΦΥΛΛΟΥ ΑΛΟΥΜΙΝΙΟΥ  
ΑΠΟ ΜΟΝΩΤΙΚΟ  
SHEET DETACHMENT FROM  
INSULATION MATERIAL

0,488 N/mm<sup>2</sup>

ΣΥΝΤΕΛΕΣΤΗΣ ΘΕΡΜΙΚΗΣ ΑΝΤΙΣΤΑΣΗΣ  
THERMAL RESISTANCE COEFFICIENT

$RD = m^2 * K/W = 0,55$

ΣΥΝΤΕΛΕΣΤΗΣ ΘΕΡΜΙΚΗΣ  
ΑΓΩΓΙΜΟΤΗΤΑΣ  
THERMAL CONDUCTIVITY COEFFICIENT

$\lambda d = W/M * K = 0,035$

# P6000 Series



P6600

P6100



P6601 Καίτη/Transom

P6101 Καίτη/Transom



P6110



P6101 Ασφάλεια 4/Safety 4

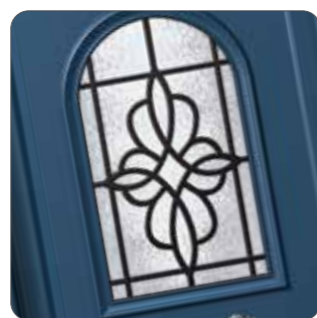

Ασφάλεια 1/Safety 1



P6111 Καίτη/Transom



P6111 Ασφάλεια/Safety 5





# P6000 Series



P6120



P6121 Ασφάλεια 2/Safety 2



P6121 Καίτη/Transom



P6690

P6190



P6196 Καίτη/Transom



P6196 Ασφάλεια 1/Safety 1



# P6000 Series



P6630

P6130



P6632 Καίτη/Transom

P6133 Καίτη/Transom



P6750

P6140



P6752 Fused 4

P6142 Fused 4



P6133 Fused 1



P6142 Καίτη/Transom

# P6000 Series



P6150



P6153 Ασφάλεια 1/Safety 1



P6700

P6200



P6151 Καίτη/Transom Inox



P6201 Deco 1



P6701 Καίτη/Transom

P6201 Καίτη/Transom

# P6000 Series



P6740

P6230



P6160



P6741 Ασφάλεια 1/Safety 1

P6231 Ασφάλεια 1/Safety 1



P6161 Ασφάλεια 5/Safety 5



P6161 Ασφάλεια 3/Safety 3



Καίτη/Transom



# P6000 Series



P6170



P6171 Ασφάλεια 4/Safety 4



P6710

P6220



P6711

P6221 Καίτη/Transom



P6171 Καίτη/Transom



P6221 Ασφάλεια 1/Safety 1

# P6000 Series



P6710

P6210



P6212 Καράβολο/Karavolo



P6212 Ασφάλεια 1/Safety 1



P6740

P6240



P6741 Καϊτι/Transom Inox

P6242 Καϊτι/Transom Inox



P6212 Καϊτι/Transom



P6242 Ασφάλεια 3/Safety 3

# P6000 Series



P6750

P6250



P6253 Καίτι/Transom



P6251 Καίτι Inox  
Transom Inox



P6253 Fused 1



P6253 Ασφάλεια 1/Safety 1



P6680

P6180



P6231 Ασφάλεια 1/Safety 1



P6182 Καίτι/Transom Inox



P6740

P6230



P6231 Καίτι/Transom

# AL 590 Σύστημα κύριας εισόδου Main entrance door system

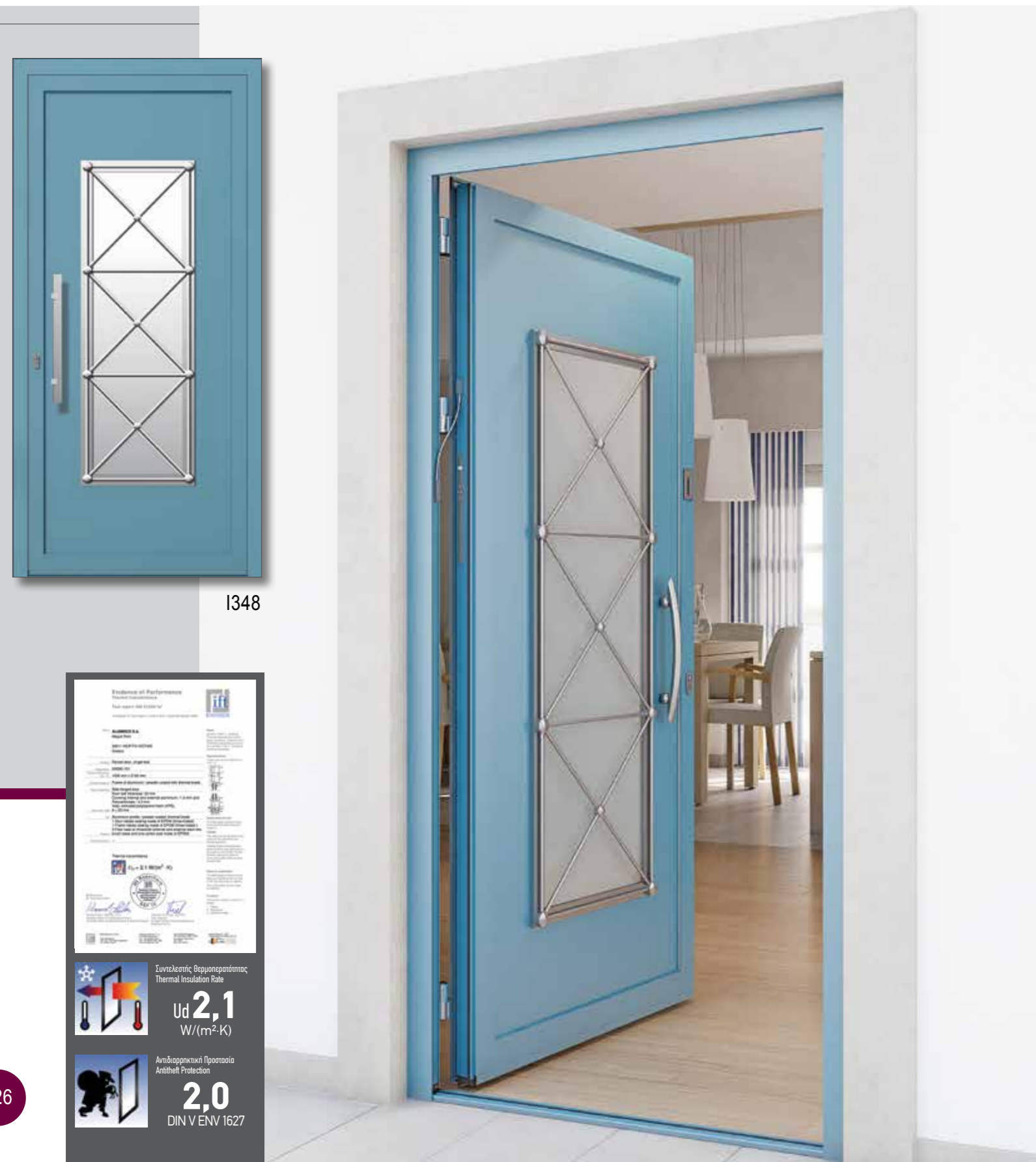

1348

## SECURITY DOOR LOCK Mortise and Falling latch INOX / NICKEL

Κλειδαριές ασφαλείας, μαχαιρωτή και γλωσσού, σε Inox & Nickel, κατάλληλες για όλες τις σειρές αλουμινίου  
Security door locks, mortise & falling latch, in Inox & Nickel, suitable for all aluminium series

### Πλεονεκτήματα

- 5ετή εγγύηση καλής λειτουργίας
- Μοναδική τιμή
- Κύλινδρος ασφαλείας με 5 πλακέ κλειδιά
- Πλάκα και αντίκρισμα και από ανοξείδωτο ατσάλι για προστασία από την βροχή και την αλμύρα
- Εξαιρετικά εύκολο στη χρήση
- Ρυθμιζόμενη γλώσσα για άνετη εφαρμογή με ακρίβεια δεξιάς ή αριστερής φοράς από την μπροστινή πλευρά για μέγιστη ευελιξία και ταχύτητα
- Έρχεται σε ειδική συσκευασία που χρησιμοποιείται σαν θήκη φύλαξης και μεταφοράς

### Advantages

- 5 year warranty
- Best price value
- Lock cylinder with 5 keys plywood
- Plate & striking plate for locks from stainless steel for protection from the rain and the saltiness
- Extremely easy to use
- Adjustable latch for a comfortable fit with accuracy, right or left direction of the front panel for maximum flexibility and swiftness
- Special packaging used as a storage box



### 1<sup>ο</sup> Σετ / 1<sup>st</sup> Set

A/A	Κωδικός σετ Set Code	Περιγραφή   Description
1	KT710-728/01	Κλειδ. 35mm Γλωσσού Inox & Κύλινδρ. 75mm ασφαλείας Lock 35mm Mortise Inox & Security Cylinder 75mm
2	KT710-728/02	Κλειδ. 35mm Γλωσσού Nickel & Κύλινδρ. 75mm ασφαλείας Lock No 35mm Mortise Nickel & Security Cylinder 75mm
3	KT710-725/01	Κλειδ. 35mm Γλωσσού Inox & Κύλινδρ. 85mm ασφαλείας Lock 35m Mortise Inox & Security Cylinder 85mm
4	KT710-725/02	Κλειδ. 35mm Γλωσσού Nickel & Κύλινδρ. 85mm ασφαλείας Lock 35mm Mortise Nickel & Security Cylinder 85mm

### 2<sup>ο</sup> Σετ / 2<sup>nd</sup> Set

A/A	Κωδικός σετ Set Code	Περιγραφή   Description
1	KT709-724	Κλειδ. 20mm Γλωσσού Inox & Κύλινδρ. 60mm απλός Lock 20mm Mortise Inox & Cylinder 60mm
2	KT712-728	Κλειδ. 30mm Γλωσσού Inox & Κύλινδρ. 75mm ασφαλείας Lock 30mm Mortise Inox & Security Cylinder 75mm
3	KT712-725	Κλειδ. 30mm Γλωσσού Inox & Κύλινδρ. 85mm ασφαλείας Lock 30mm Mortise Inox & Security Cylinder 85mm
4	KT703-728	Κλειδ. 35mm Μαχαιρωτή Inox & Κύλινδρ. 75mm ασφαλείας Lock 35mm Falling latch Inox & Security Cylinder 75mm
5	KT703-725	Κλειδ. 35mm Μαχαιρωτή Inox & Κύλινδρ. 85mm ασφαλείας Lock 35mm Falling latch Inox & Security Cylinder 85mm

Συσκευασία 30 τεμαχίων  
Packaging of 30 pieces



# Ταμπλαδάκια / Special size panels

# FP-20 Aluplast / PVC

Ειδικά πάνελ για κουζινοπόρτες και παραδοσιακά παράθυρα  
Special size panels for kitchen doors and windows

Επίπεδα πάνελ αλουμινίου  
Aluminium flat panels



- Ενισχυμένη αντοχή σε χτυπήματα
- Σκληρή - Άκαμπτη επιφάνεια
- Αυξημένη Ηχομόνωση
- Ελαφρύ
- Κατάλληλο για ποικίλες εφαρμογές
- Highly resistant material
- Hard, rigid surface
- Increased sound insulation
- Light weight
- Appropriate for various applications

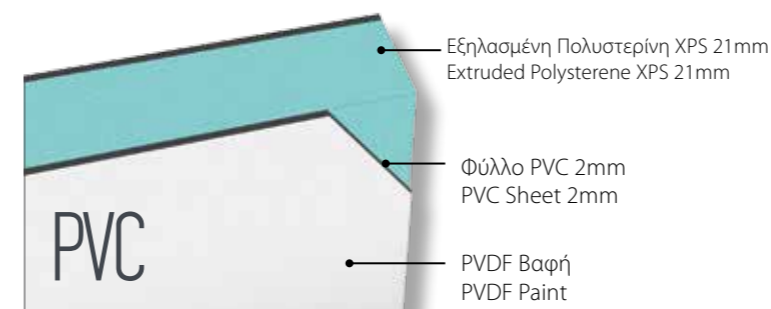

ΣΥΝΟΛΙΚΟ ΠΑΧΟΣ ΠΑΝΕΛ TOTAL PANEL THICKNESS	<b>20mm</b>
ΑΠΟΚΟΛΛΗΣΗ ΦΥΛΛΟΥ ALUMINIUM SHEET DETACHMENT	
ΣΥΝΤΕΛΕΣΤΗΣ ΘΕΡΜΙΚΗΣ ΑΝΤΙΣΤΑΣΗΣ THERMAL RESISTANCE COEFFICIENT	<b>0,488 N/mm<sup>2</sup></b>
ΣΥΝΤΕΛΕΣΤΗΣ ΘΕΡΜΙΚΗΣ ΑΓΩΓΙΜΟΤΗΤΑΣ THERMAL CONDUCTIVITY COEFFICIENT	<b>RD=m<sup>2</sup> * K/W=0,55</b>
ΣΥΝΤΕΛΕΣΤΗΣ ΘΕΡΜΙΚΗΣ ΑΓΩΓΙΜΟΤΗΤΑΣ THERMAL CONDUCTIVITY COEFFICIENT	<b>λD=W/M * K=0,035</b>
ΚΡΑΜΑ ALLOY	<b>AL 3105/H44</b>
ΒΑΦΗ ΕΠΙΦΑΝΕΙΑΣ SURFACE COATING	<b>PVDF, PRIMER</b>
ΠΑΧΟΣ ΑΛΟΥΜΙΝΙΟΥ ALUMINIUM THICKNESS	<b>0,5mm</b>
ΠΑΧΟΣ PVC PVC THICKNESS	<b>2mm</b>
ΠΑΧΟΣ ΠΟΛΥΣΤΕΡΙΝΗΣ POLYSTYRENE THICKNESS	<b>14mm</b>

	Code	Dimension
Aluplast	FP090-210/5	900x2100
	FP120-250/5	1200x2500
PVC	FP100-200/7	1000x2000
	FP150-300/7	1500x3000

# Χειρολαβές / Handles

Επιλογές απο ποικιλία σχεδίων και υλικών, που συνδυάζονται άψογα με όλες τις πόρτες  
Wide selection of handle designs and materials, to match any type of door

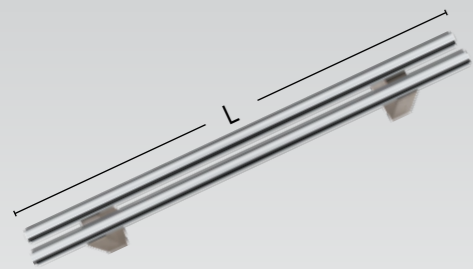

L40cm 0871X2-040  
L50cm 0871X2-050  
L60cm 0871X2-060  
L80cm 0871X2-080  
L100cm 0871X2-100  
L120cm 0871X2-120  
L150cm 0871X2-150  
L160cm 0871X2-160  
L180cm 0871X2-180  
L200cm 0871X2-200

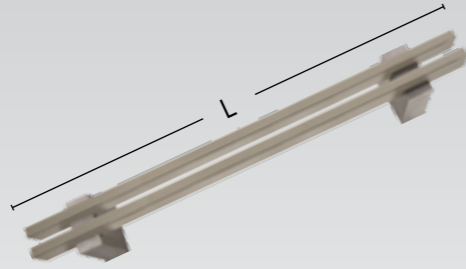

L40cm 0873X1-040  
L50cm 0873X1-050  
L60cm 0873X1-060  
L80cm 0873X1-080  
L100cm 0873X1-100  
L120cm 0873X1-120  
L150cm 0873X1-150  
L160cm 0873X1-160  
L180cm 0873X1-180  
L200cm 0873X1-200

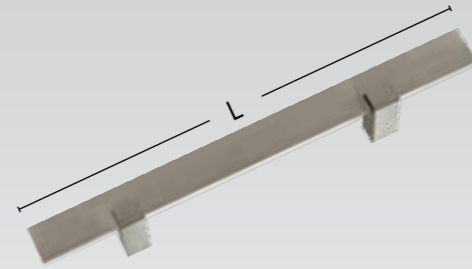

L40cm 0879X3-040  
L50cm 0879X3-050  
L60cm 0879X3-060  
L80cm 0879X3-080  
L100cm 0879X3-100  
L120cm 0879X3-120  
L150cm 0879X3-150  
L160cm 0879X3-160  
L180cm 0879X3-180  
L200cm 0879X3-200

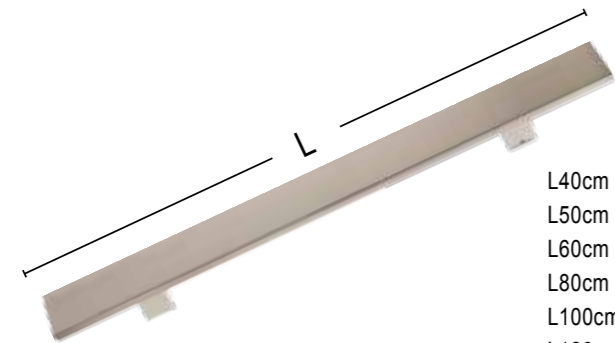

L40cm 0669X3-040  
L50cm 0669X3-050  
L60cm 0669X3-060  
L80cm 0669X3-080  
L100cm 0669X3-100  
L120cm 0669X3-120  
L150cm 0669X3-150  
L160cm 0669X3-160  
L180cm 0669X3-180  
L200cm 0669X3-200

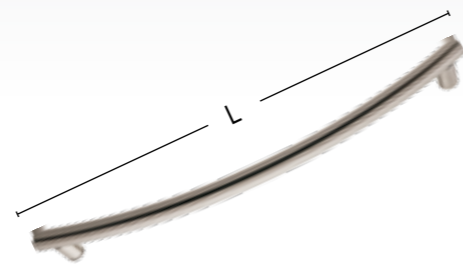

L45,5cm 0461X3-040  
L65,7cm 0461X3-060  
L85,8cm 0461X3-080  
L105,9cm 0461X3-100

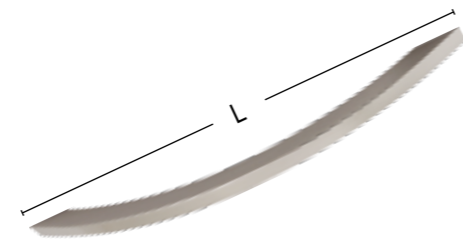

L30cm 0883X1-025  
L55,5cm 0883X1-050

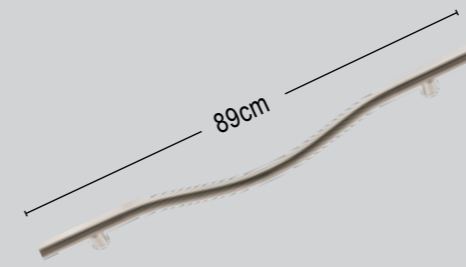

0617X3-089

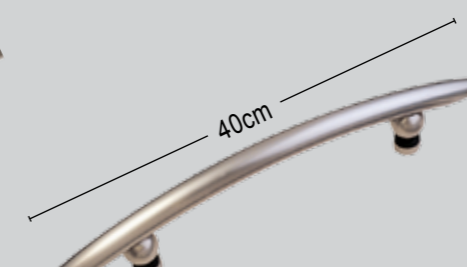

102

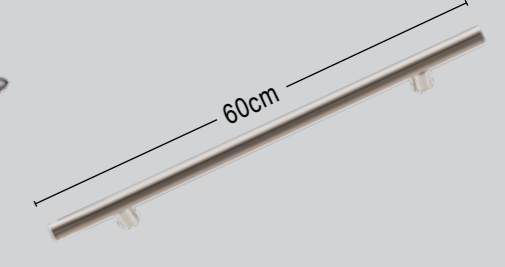

165-500

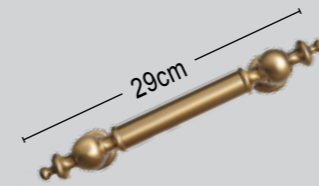

520

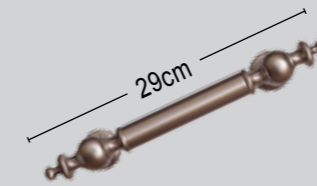

520S

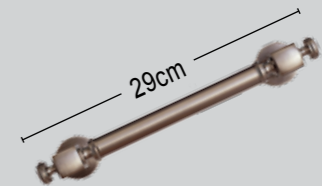

525



165-400



Ø50mm 0449P3-005  
Ø60mm 0449P3-006  
Ø70mm 0449P3-007  
Ø80mm 0449P3-008



Ø60mm 0697P4-006  
Ø80mm 0697P4-008

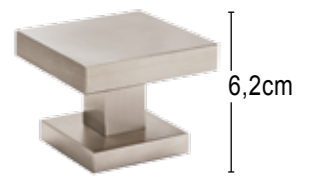

60x60mm 0785P4-006  
80x80mm 0785P4-008



15-25mm Gold E3000-826/1  
15-25mm Nickel E3000-826/2



Ροζέτα Inox 304 EA590-720U  
Rosette Inox 304

# ALUMINCO

ALUMINIUM BUILDING SYSTEMS

INOFITA VIOTIA 32011 GREECE

TEL: +30 22620 47000

FAX: +30 22620 47092

info@aluminco.com

export@aluminco.com

[www.aluminco.com](http://www.aluminco.com)



*Για να μεταβείτε στο [www.aluminco.com](http://www.aluminco.com)  
σάρωστε με το barcode scanner του τηλεφώνου  
σας για να αναλυθείτε το σύνδεσμο.*

*To go to [www.aluminco.com](http://www.aluminco.com) simply use your  
phone's barcode scanner and follow the link.*